

Quick Installation Guide

NEED TECH HELP?

- www.cudy.com/qr_vg_ap
- www.cudy.com
- support@cudy.com
- www.cudy.com/download



810600195

1 Power Supply

Method 1: Via Power Adapter

Plug one end of the provided power adapter into the DC POWER port of the AP and the other end to a standard electrical wall outlet.

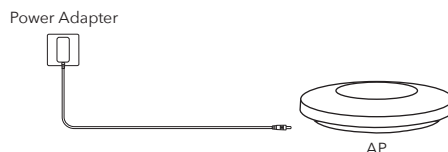

Method 2: Via PoE Switch

Connect an Ethernet cable from the PoE switch to the Ethernet port.

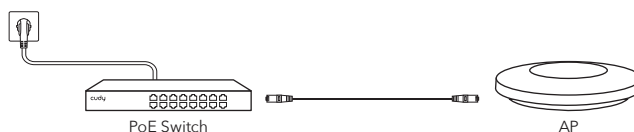

Method 3: Via PoE Adapter

Connect an Ethernet cable from the Ethernet port of the AP device to the PoE port of the provided PoE adapter.

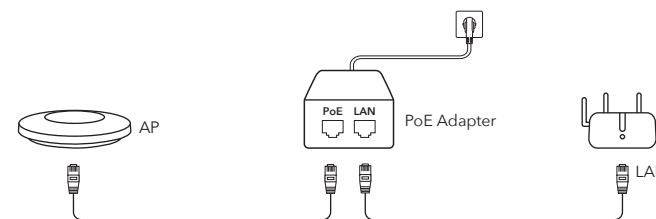

LED and Button

Off	
Red	
Blue	
Flashing blue	
Yellow	
Flashing yellow	
Red, blue, and yellow alternate	
Reset Button	Red and blue alternate

2 Software Configuration

Choose from the following methods to configure your APs.

Method 1: Standalone Mode

To configure and manage APs separately.

Note 1:

1. Before you start, be sure to power up and connect your devices according to the topology figure.
2. A DHCP server (typically a router with DHCP function enabled) is required to assign IP addresses to the APs and clients in your local network.

Note 2:

If the router you use is a Cudy mesh WiFi router (firmware version: 1.15.28 or later), then the access point will auto work as an add-on mesh unit and share the same WiFi network name and password with the Cudy router you connect.

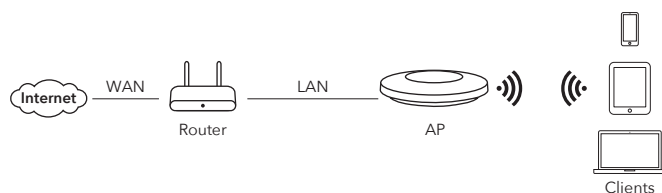

1. Connect wirelessly by using the default SSID printed on the bottom label of the product.

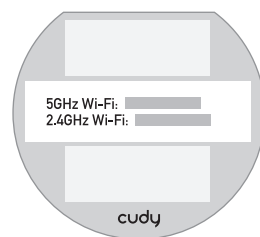

2. Launch a web browser and enter <http://cudyap.net/> in the address bar. Use **admin** as log in Password .

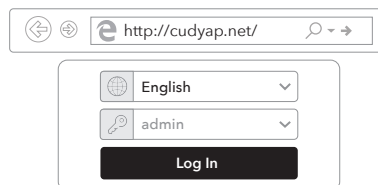

3. Click "**Quick Setup**", the window below will pop up, please follow the step-by-step instructions to set up the internet connection.

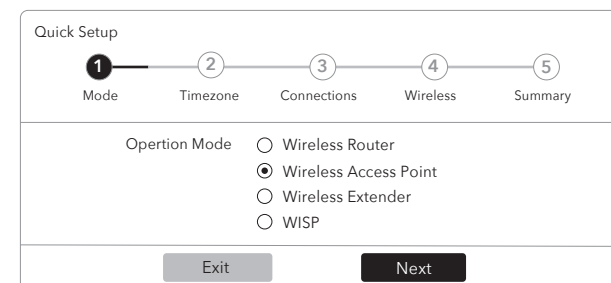

Method 2: Controller Mode

Note:

Before you start, be sure to power up and connect your devices according to the topology figure. For Hardware Controller, refer to its Installation Guide for details.

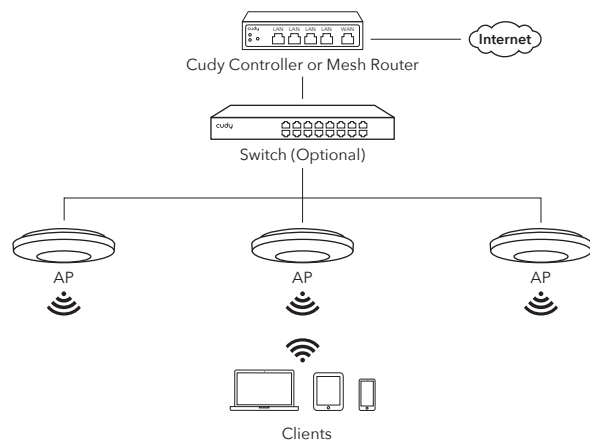

EU Declaration of Conformity

1. English:

Cudy hereby declares that the device is in compliance with the essential requirements and other relevant provisions of directives 2014/53/EU, 2009/125/EC and 2011/65/EU. The original EU declaration of conformity can be found at <http://www.cudy.com/ce>.

2. Deutsch:

Cudy erklärt hiermit, dass das Gerät den grundlegenden Anforderungen und anderen relevanten Bestimmungen der Richtlinien 2014/53/EU, 2009/125/EG und 2011/65/EU entspricht. Die originale EU-Konformitätserklärung finden Sie unter <http://www.cudy.com/ce>.

3. Español:

Cudy declara por la presente que el dispositivo cumple con los requisitos esenciales y otras disposiciones relevantes de las directivas 2014/53/EU, 2009/125/EC y 2011/65/EU. La declaración de conformidad de la UE original se puede encontrar en <http://www.cudy.com/ce>.

4. Italiano:

Cudy dichiara che il dispositivo è conforme ai requisiti essenziali e ad altre disposizioni pertinenti delle direttive 2014/53/UE, 2009/125/CE e 2011/65/UE. La dichiarazione di conformità UE originale è disponibile all'indirizzo <http://www.cudy.com/ce>.

5. Français:

Cudy déclare par la présente que l'appareil est conforme aux exigences essentielles et aux autres dispositions pertinentes des directives 2014/53/UE, 2009/125/CE et 2011/65/UE. La déclaration de conformité UE originale est disponible sur <http://www.cudy.com/ce>.

6.Ελληνικό:

Η Cudy δηλώνει με το παρόν ότι η συσκευή συμμορφώνεται με τις βασικές απαιτήσεις και άλλες σχετικές διατάξεις των οδηγιών 2014/53/ΕΕ, 2009/125/ΕΚ και 2011/65/ΕΕ. Η αρχική δήλωση συμμόρφωσης ΕΕ βρίσκεται στη διεύθυνση <http://www.cudy.com/ce>.

Hardware Installation

Scan QR code or visit <https://www.cudy.com/apxz> for the hardware installation manual.

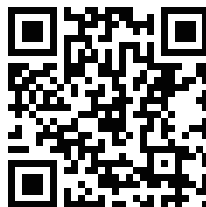

WEEE

According to the EU Directive on Waste Electrical and Electronic Equipment (WEEE - 2012/19 / EU), this product must not be disposed of as normal household waste.

Instead, they should be returned to the place of purchase or taken to a public collection point for recyclable waste. By ensuring this product is disposed of correctly, you will help prevent potential negative consequences for the environment and human health, which could otherwise be caused by inappropriate waste handling of this product. For more information, please contact your local authority or the nearest collection point. Improper disposal of this type of waste may result in penalties according to national regulations.

7. Nederlands:

Cudy verklaart hierbij dat het apparaat in overeenstemming is met de essentiële vereisten en andere relevante bepalingen van de richtlijnen 2014/53/EU, 2009/125/EG en 2011/65/EU. De originele EU-conformiteitsverklaring is te vinden op <http://www.cudy.com/ce>.

8. Português:

A Cudy declara que o dispositivo está em conformidade com os requisitos essenciais e outras disposições relevantes das diretivas 2014/53/UE, 2009/125/EC e 2011/65/UE. A declaração de conformidade original da UE pode ser encontrada em <http://www.cudy.com/ce>.

9. Polski:

Cudy oświadcza niniejszym, że urządzenie jest zgodne z zasadniczymi wymaganiami i innymi stosownymi postanowieniami dyrektyw 2014/53/UE, 2009/125/WE i 2011/65/UE. Oryginalną deklarację zgodności UE można znaleźć na stronie <http://www.cudy.com/ce>.

10. Türkçe:

Cudy, cihazın 2014/53/EU, 2009/125/EC ve 2011/65/EU direktiflerinin temel gereksinimlerine ve diğer ilgili hükümlerine uygun olduğunu beyan eder. Orijinal AB uygunluk beyanı <http://www.cudy.com/ce> adresinde bulunabilir.

11. Norsk:

Cudy erklærer herved at enheten er i samsvar med de grunnleggende kravene og andre relevante bestemmelser i direktivene 2014/53/EU, 2009/125/EC og 2011/65/EU. Den originale EU-samsvarserklæringen finner du på <http://www.cudy.com/ce>.

12. Dansk:

Cudy erklærer hermed, at enheden er i overensstemmelse med de væsentlige krav og andre relevante bestemmelser i direktivene 2014/53/EU, 2009/125/EC og 2011/65/EU. Den originale EU-overensstemmelseserklæring kan findes på <http://www.cudy.com/ce>.

GNU General Public License Notice

The software code in this product was created by third parties and is licensed under the GNU General Public License ("GPL"). If applicable, Cudy ("Cudy" in this context refers to the Cudy entity offering respective software for download or being in charge of the distribution of products that contain respective code) makes the corresponding GPL source code available upon request via the official website, either independently or with the assistance of third parties (such as Shenzhen Cudy Technology Co., Ltd.).

For GPL-related questions, email support@cudy.com. In addition, Cudy offers a GPL-Code-Centre under <https://www.cudy.com/gplcodecenterdownload> where users can get the GPL source codes used in Cudy products for free. Please note, that the GPL-Code-Centre is only provided as a courtesy to Cudy's customers but may neither offer a full set of source codes used in all products nor always provide the latest or actual version of such source codes.

The GPL code used in this product is subject to the copyrights of one or more authors and is subject to the terms of the license. It is provided WITHOUT ANY WARRANTY.

FCC Statements:

This device complies with part 15 of the FCC Rules. Operation is subject to the following two conditions: (1) This device may not cause harmful interference, and (2) this device must accept any interference received, including interference that may cause undesired operation.

12. Dansk:

Cudy erklærer hermed, at enheden er i overensstemmelse med de væsentlige krav og andre relevante bestemmelser i direktivene 2014/53/EU, 2009/125/EC og 2011/65/EU. Den originale EU-overensstemmelseserklæring kan findes på <http://www.cudy.com/ce>.

13. Suomi:

Cudy vakuuttaa täten, että laite on direktiivien 2014/53/EU, 2009/125/EC ja 2011/65/EU olennaisten vaatimusten ja muiden asiaankuuluvien määräysten mukainen. Alkuperäinen EU-vaatimustenmukaisuusvakuutus löytyy osoitteesta <http://www.cudy.com/ce>.

14. Svenska:

Cudy intygar härmed att enheten överensstämmer med de väsentliga kraven och andra relevanta bestämmelser i direktiven 2014/53/EU, 2009/125/EC och 2011/65/EU. Den ursprungliga EU-försäkran om överensstämmelse finns på <http://www.cudy.com/ce>.

15. Čeština:

Cudy tímto prohlašuje, že zařízení je v souladu se základními požadavky a dalšími příslušnými ustanoveními směrnic 2014/53/EU, 2009/125/ES a 2011/65/EU. Originál EU prohlášení o shodě lze nalézt na <http://www.cudy.com/ce>.

16. Slovenčina:

Cudy týmto vyhlasuje, že zariadenie je v súlade so základnými požiadavkami a ďalšími príslušnými ustanoveniami smerníc 2014/53/EU, 2009/125/ES a 2011/65/EU. Originál EÚ vyhlásenia o zhode možno nájsť na <http://www.cudy.com/ce>.

