

## DS-2DE7A425MWG-EB 4 MP 25 × Network Speed Dome

ColorVu

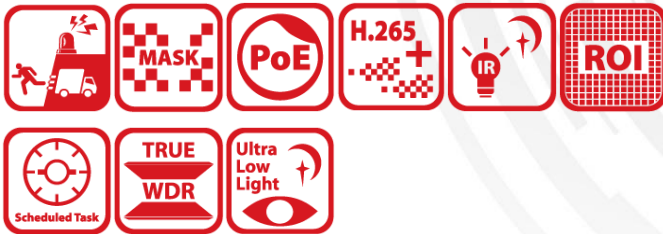

Hikvision DS-2DE7A425MWG-EB 4 MP 25 × Network Speed Dome adopts 1/2.8" progressive scan CMOS chip. With the 25 × optical zoom lens, the camera offers more details over expansive areas. This series of cameras can be widely used for wide ranges of high-definition, such as the rivers, roads, railways, airports, squares, parks, scenic spots, and venues, etc. Empowered by deep learning algorithms, Hikvision AcuSense technology brings human and vehicle targets classification alarms to front- and back-end devices. The system focuses on human and vehicle targets, vastly improving alarm efficiency and effectiveness.

Hikvision has been dedicated to develop products with security since established.

Hikvision always follows security by design principle and has adopted many methods of security technologies into our product development lifecycle, including terminal security, data security, application security, network security, and privacy protection. In the meantime, the security technologies used by Hikvision are all in compliance with local applicable laws and safety regulations. These security measures could enhance product's cyber security protection capability and protect your devices as well as your data from malicious cyber attacks.

- 24/7 colorful imaging
- High quality imaging with 4 MP resolution
- Audio visual alarm: The white flashing light and audible warning can be triggered by certain events
- 25 × optical zoom and 16 × digital zoom provide close up views over expansive areas
- Expansive night view with up to 150 m IR distance and 100 m white light
- Focuses on human and vehicle targets classification based on deep learning
- Face capture: Up to 5 faces captured at the same time

## ▪ Specification

Camera	
Image Sensor	1/2.8" Progressive Scan CMOS
Max. Resolution	2688 × 1520
Min. Illumination	Color: 0.005 Lux @ (F1.5, AGC ON), 0 Lux with light, B/W: 0.001 Lux @ (F1.5, AGC ON), 0 Lux with IR
Shutter Speed	1/1 s to 1/30000 s
Day & Night	IR cut filter
Zoom	25 × optical, 16 × digital
Slow Shutter	Yes
Lens	
Focal Length	5.9 to 147.5 mm
FOV	Horizontal field of view: 60.2° to 3.2°, vertical field of view: 35.2° to 1.7°, diagonal field of view: 67.4° to 3.4°
Focus	Auto, semi-auto, manual
Aperture	Max. F1.5
Zoom Speed	Approx. 4.9 s
Illuminator	
Supplement Light Type	Hybrid (IR and White Light)
Supplement Light Range	White light: up to 100 m IR: up to 150 m
PTZ	
Movement Range (Pan)	360°
Movement Range (Tilt)	-15° to 90° (auto flip)
Pan Speed	Pan speed: configurable from 0.1° to 160°/s; preset speed: 240°/s
Tilt Speed	Tilt speed: configurable from 0.1° to 120°/s, preset speed 200°/s
Proportional Pan	Yes
Presets	300
Preset Freezing	Yes
Patrol Scan	8 patrols, up to 32 presets for each patrol
Pattern Scan	4 pattern scans
Park Action	Preset, patrol scan, pattern scan, auto scan, tilt scan, random scan, frame scan, panorama scan
3D Positioning	Yes
PTZ Status Display	Yes
Scheduled Task	Preset, pattern scan, patrol scan, auto scan, tilt scan, random scan, frame scan, panorama scan, dome reboot, dome adjust, aux output
Power-off Memory	Yes
Video	
Main Stream	50 Hz: 25 fps (2688 × 1520, 2560 × 1440, 1920 × 1080, 1280 × 960, 1280 × 720), 60 Hz: 30 fps (2688 × 1520, 2560 × 1440, 1920 × 1080, 1280 × 960, 1280 × 720)
Sub-Stream	50 Hz: 25 fps (704 × 576, 640 × 480, 352 × 288) 60 Hz: 30 fps (704 × 480, 640 × 480, 352 × 240)
Third Stream	50 Hz: 25 fps (1920 × 1080, 1280 × 960, 1280 × 720, 704 × 576, 640 × 480, 352 × 288) 60 Hz: 30 fps (1920 × 1080, 1280 × 960, 1280 × 720, 704 × 480, 640 × 480, 352 × 240)

Video Compression	Main stream: H.265+/H.265/H.264+/H.264 Sub-stream: H.265/H.264/MJPEG Third stream: H.265/H.264/MJPEG
Video Bit Rate	32 kbps to 16384 kbps
H.264 Type	Baseline Profile/Main Profile/High Profile
H.265 Type	Main Profile
Scalable Video Coding (SVC)	H.264 and H.265 encoding
Region of Interest (ROI)	8 fixed regions for each stream
<b>Audio</b>	
Audio Compression	G.711alaw, G.711ulaw, G.722.1, G.726, MP2L2, PCM, AAC-LC, MP3
Audio Bit Rate	MP2L2: 32kbps, 40kbps, 48kbps, 56kbps, 64kbps, 80kbps, 96kbps, 112kbps, 128kbps, 144kbps, 160kbps, 192kbps, AAC-LC: 16 kbps, 32 kbps, 64 kbps
Audio Sampling Rate	AAC-LC: 16kHz, 32kHz, 48kHz, PCM: 8kHz, 16kHz, 32kHz, 48kHz, MP2L2: 16kHz, 32kHz, 48kHz
Environment Noise Filtering	Yes
<b>Network</b>	
Protocols	IPv4/IPv6, HTTP, HTTPS, 802.1x, QoS, FTP, SMTP, UPnP, SNMP, DNS, DDNS, NTP, RTSP, RTCP, RTP, TCP/IP, UDP, IGMP, ICMP, DHCP, PPPoE, Bonjour, WebSocket, WebSockets
Simultaneous Live View	Up to 20 channels
API	Open Network Video Interface (Version 19.12, Profile S, Profile G, Profile T), ISAPI, SDK, ISUP
User/Host	Up to 32 users, 3 user levels: administrator, operator, and user
Security	Password protection, complicated password, HTTPS encryption, 802.1X authentication (EAP-TLS, EAP-LEAP, EAP-MD5), watermark, IP address filter, basic and digest authentication for HTTP/HTTPS, RTP/RTSP over HTTPS, control timeout settings, security audit log, TLS 1.2, TLS 1.3, host authentication (MAC address)
Network Storage	NAS (NFS, SMB/CIFS), auto network replenishment (ANR)
Client	iVMS-4200, HikCentral Pro, Hik-Connect
Web Browser	IE11, Chrome 57+, Firefox 52+, Safari 12+
<b>Image</b>	
Image Settings	Saturation, brightness, contrast, sharpness, gain, and white balance adjustable by client software or web browser
Day/Night Switch	Day, Night, Auto, Schedule
Wide Dynamic Range (WDR)	120 dB
SNR	> 52 dB
Defog	Digital defog
Image Stabilization	EIS
Image Enhancement	BLC, HLC, 3D DNR
Privacy Mask	24 programmable polygon privacy masks, mask color or mosaic configurable
Regional Focus	Yes
Regional Exposure	Yes
<b>Interface</b>	
Ethernet Interface	1 RJ45 10M/100M self-adaptive Ethernet port
On-board Storage	Built-in memory card slot, support microSD/microSDHC/microSDXC card, up to 512 GB
Built-in Speaker	1 built-in speaker with effective distance reaching max. 30 meters

Audio	1 input (line in), max. input amplitude: 2-2.4 vpp, input impedance: 1 kΩ ± 10%; 1 output (line out), line level, output impedance: 600 Ω
Alarm	2 inputs, 1 output
Reset	Yes
<b>Event</b>	
Basic Event	Motion detection, video tampering alarm, exception, alarm input and output
Smart Event	Line crossing detection, intrusion detection, region entrance detection, region exiting detection, unattended baggage detection, object removal detection, audio exception detection
Linkage	Upload to FTP/NAS/memory card, notify surveillance center, send email, trigger alarm output, trigger recording, audible warning, white light flashing, and PTZ actions (such as preset, patrol scan, pattern scan)
Smart Tracking	Manual tracking, auto-tracking
<b>General</b>	
Power	36 VDC, max. 42 W (including max. 12 W for IR and max. 2 W for heater); Hi-PoE
Dimension	Ø220 mm × 360.2 mm (Ø8.66" × 14.18")
Weight	Approx. 5.5 kg (12.13 lb.)
Material	ADC12
Operating Condition	-30 °C to 65 °C (-22 °F to 149 °F). Humidity 90% or less (non-condensing)
Demist	Yes
<b>Approval</b>	
EMC	CE-EMC (EN 55032: 2015, EN 61000-3-2: 2019, EN 61000-3-3: 2013 + A1: 2019, EN 50130-4: 2011 + A1: 2014),RCM (AS/NZS CISPR 32: 2015),IC (ICES-003: Issue 7),KC (KN 32: 2015, KN 35: 2015)
Safety	UL (UL 62368-1),CB (IEC 62368-1: 2014 + A11),CE-LVD (EN 62368-1: 2014/A11: 2017),LOA (IEC/EN 60950-1)
Environment	CE-RoHS (2011/65/EU); WEEE (2012/19/EU); Reach (Regulation (EC) No 1907/2006)
Protection	IP66 (IEC 60529-2013), IK10 (excluding glass window), TVS 6000V lightning protection, surge protection and voltage transient protection

## ▪ DORI

The DORI (detect, observe, recognize, identify) distance gives the general idea of the camera ability to distinguish persons or objects within its field of view. It is calculated based on the camera sensor specification and the criteria given by EN 62676-4: 2015.

DORI	Detect	Observe	Recognize	Identify
Definition	25 px/m	63 px/m	125 px/m	250 px/m
Distance (Tele)	2200.0 m (7217.8 ft.)	873.0 m (2864.2 ft.)	440.0 m (1443.6 ft.)	220.0 m (721.8 ft.)

## ▪ Available Model

DS-2DE7A425MWG-EB

## ▪ Dimension

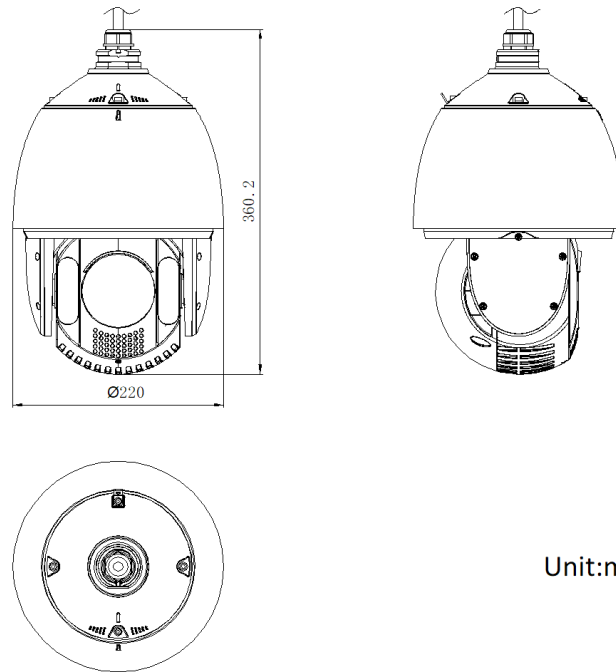

















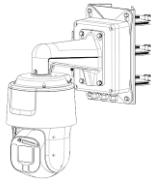
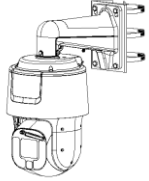



Unit:mm

▪ **Accessory**

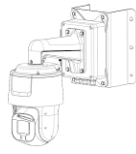
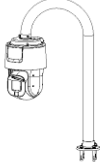
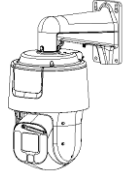
▪ **Optional**

DS-1604ZJ-BOX-CO RNER Wall mount	DS-1604ZJ-box Wall mount	DS-1604ZJ Wall mount	DS-1660ZJ Wall mount	DS-1661ZJ Pendant Mount
<b>DS-1662ZJ Pendant Mount</b>	<b>DS-1667ZJ Pendant Mount</b>	<b>DS-1673ZJ Vertical pole mount</b>	<b>DS-1604ZJ-BOX-PO LE Vertical pole mount</b>	<b>DS-1684ZJ Vertical pole mount</b>

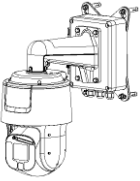
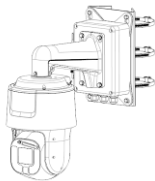
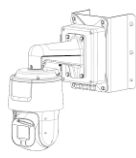
				
				
<b>DS-1604ZJ-pole</b> <b>Vertical pole mount</b>	<b>DS-1663ZJ</b> <b>In-ceiling mount</b>	<b>DS-1604ZJ-corner</b> <b>Corner mount</b>	<b>DS-1619ZJ</b> <b>Others</b>	<b>DS-1602ZJ</b> <b>Wall mount</b>
				
				
<b>DS-1674ZJ</b> <b>Junction box</b>	<b>DS-4650ZJ-WC</b> <b>Vertical pole mount</b>	<b>DS-4660ZJ-WC</b> <b>Corner mount</b>		
				
				

**Headquarters**

No.555 Qianmo Road, Binjiang District,  
Hangzhou 310051, China  
T +86-571-8807-5998  
www.hikvision.com



Follow us on social media to get the latest product and solution information.

