

©2020 Hangzhou Hikvision Digital Technology Co., Ltd. All rights reserved.

About this Manual

The Manual includes instructions for using and managing the Product. Pictures, charts, images and all other information hereinafter are for description and explanation only. The information contained in the Manual is subject to change, without notice, due to firmware updates or other reasons. Please find the latest version of this Manual at the Hikvision website (<https://www.hikvision.com/>).

Please use this Manual with the guidance and assistance of professionals trained in supporting the Product.

HIKVISION and other Hikvision's trademarks and logos are the properties of Hikvision in various jurisdictions. Other trademarks and logos mentioned are the properties of their respective owners.

Disclaimer

TO THE MAXIMUM EXTENT PERMITTED BY APPLICABLE LAW, THIS MANUAL AND THE PRODUCT DESCRIBED, WITH ITS HARDWARE, SOFTWARE AND FIRMWARE, ARE PROVIDED "AS IS" AND "WITH ALL FAULTS AND ERRORS". HIKVISION MAKES NO WARRANTIES, EXPRESS OR IMPLIED, INCLUDING WITHOUT LIMITATION, MERCHANTABILITY, SATISFACTORY QUALITY, OR FITNESS FOR A PARTICULAR PURPOSE. THE USE OF THE PRODUCT BY YOU IS AT YOUR OWN RISK. IN NO EVENT WILL HIKVISION BE LIABLE TO YOU FOR ANY SPECIAL, CONSEQUENTIAL, INCIDENTAL, OR INDIRECT DAMAGES, INCLUDING, AMONG OTHERS, DAMAGES FOR LOSS OF BUSINESS PROFITS, BUSINESS INTERRUPTION, OR LOSS OF DATA, CORRUPTION OF SYSTEMS, OR LOSS OF DOCUMENTATION, WHETHER BASED ON BREACH OF CONTRACT, TORT (INCLUDING NEGLIGENCE), PRODUCT LIABILITY, OR OTHERWISE, IN CONNECTION WITH THE USE OF THE PRODUCT, EVEN IF HIKVISION HAS BEEN ADVISED OF THE POSSIBILITY OF SUCH DAMAGES OR LOSS.

YOU AGREE TO USE THIS PRODUCT IN COMPLIANCE WITH ALL APPLICABLE LAWS, AND YOU ARE SOLELY RESPONSIBLE FOR ENSURING THAT YOUR USE CONFORMS TO THE APPLICABLE LAW. ESPECIALLY, YOU ARE RESPONSIBLE, FOR USING THIS PRODUCT IN A MANNER THAT DOES NOT INFRINGE ON THE RIGHTS OF THIRD PARTIES, INCLUDING WITHOUT LIMITATION, RIGHTS OF PUBLICITY, INTELLECTUAL PROPERTY RIGHTS, OR DATA PROTECTION AND OTHER PRIVACY RIGHTS. YOU SHALL NOT USE THIS PRODUCT FOR ANY PROHIBITED END-USES, INCLUDING THE DEVELOPMENT OR PRODUCTION OF WEAPONS OF MASS DESTRUCTION, THE DEVELOPMENT OR PRODUCTION OF CHEMICAL OR BIOLOGICAL WEAPONS, ANY ACTIVITIES IN THE CONTEXT RELATED TO ANY NUCLEAR EXPLOSIVE OR UNSAFE NUCLEAR FUEL-CYCLE, OR IN SUPPORT OF HUMAN RIGHTS ABUSES.

IN THE EVENT OF ANY CONFLICTS BETWEEN THIS MANUAL AND THE APPLICABLE LAW, THE LATER PREVAILS.



This product and - if applicable - the supplied accessories too are marked with "CE" and comply therefore with the applicable harmonized European standards listed under the EMC Directive 2014/30/EU, RE Directive 2014/53/EU, the RoHS Directive 2011/65/EU.



2012/19/EU (WEEE directive): Products marked with this symbol cannot be disposed of as unsorted municipal waste in the European Union. For proper recycling, return this product to your local supplier upon the purchase of equivalent new equipment, or dispose of it at designated collection points. For more information see: www.recyclethis.info



replacement of a battery with an incorrect type that can defeat a safeguard (for example, in the case of some lithium battery types);
- disposal of a battery into fire or a hot oven, or mechanically crushing or cutting of a battery, that can result in an explosion;
- leaving a battery in an extremely high temperature surrounding environment that can result in an explosion or the leakage of flammable liquid or gas; and
- a battery subjected to extremely low air pressure that may result in an explosion or the leakage of flammable liquid or gas

2006/66/EC (battery directive): This product contains a battery that cannot be disposed of as unsorted municipal waste in the European Union. See the product documentation for specific battery information. The battery is marked with this symbol, which may include lettering to indicate cadmium (Cd), lead (Pb), or mercury (Hg). For proper recycling, return the battery to your supplier or to a designated collection point. For more information see: www.recyclethis.info

1 Appearance

CAUTION

IF THE BATTERY COMPARTMENT DOES NOT CLOSE SECURELY, STOP USING THE PRODUCT AND KEEP IT AWAY FROM CHILDREN.

CAUTION

CHEMICAL BURNING DANGER DO NOT SWALLOW THE BATTERY KEEP NEW AND USED BATTERIES AWAY FROM THE CHILDREN.

IF YOU THINK BATTERIES MIGHT HAVE BEEN SWALLOWED OR PLACED INSIDE ANY PART OF THE BODY, SEEK IMMEDIATE MEDICAL ATTENTION.

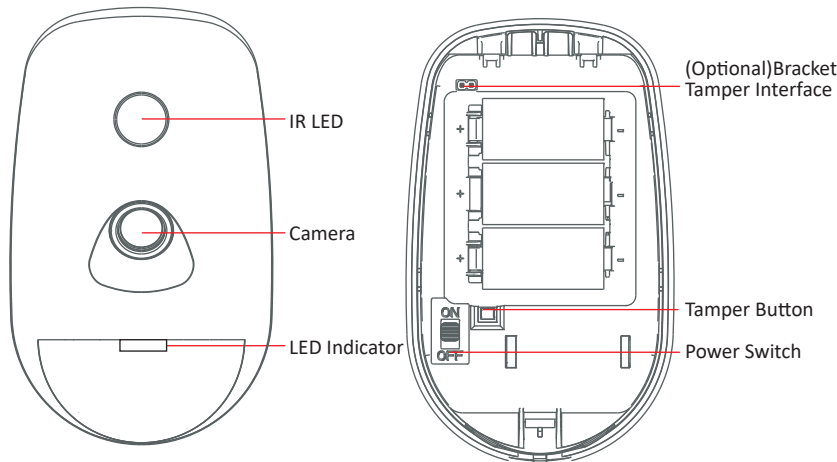

CAUTION

RISK OF EXPLOSION IF BATTERY IS REPLACED BY AN INCORRECT TYPE. REPLACEMENT OF A BATTERY WITH AN INCORRECT TYPE THAT CAN DEFEAT A SAFEGUARD. REPLACE ALL BATTERIES AT THE SAME TIME. DO NOT MIX OLD AND NEW BATTERIES.

CAUTION

DISPOSE OF USED BATTERIES ACCORDING TO THE INSTRUCTIONS AND LOCAL REGULATION.

2 Enrollment

Note: The enrollment progress will be completed in 3 to 10 seconds normally.

1. Log in to the APP Store, download and install the App.
2. Power on the security control panel.
3. Log in the APP and tap the icon "+". Scan the QR code or input the control panel serial No. to add the control panel.

1 Enroll the Peripheral Locally

1. In the APP, tap the "Enrollment Mode" button on the control panel page to make the control panel enter the enrollment status.
2. Loosen the screw and remove rear panel.
3. Power on the peripheral, and it will be automatically enrolled to the control panel.

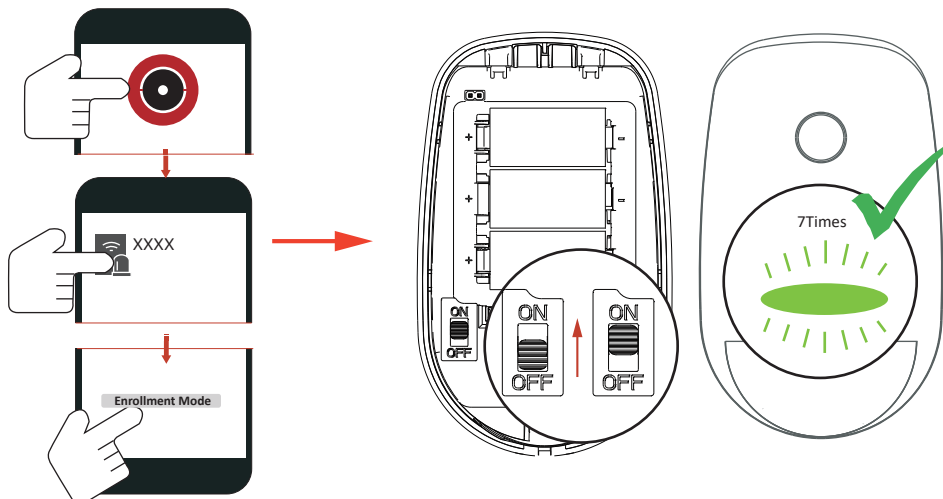

Note: make the device power off, hold the tamper switch and then power on for re-enrollment synchronously.
The distance between the detector and AXPRO should be less than 50 cm.

2 Enroll the Peripheral with QR and serial No.

1. In the APP, tap the icon "+" and scan the QR code or serial No. on the peripheral.
2. Loosen the screw and remove rear panel.
3. Power on the peripheral, and it will be automatically enrolled to the control panel.

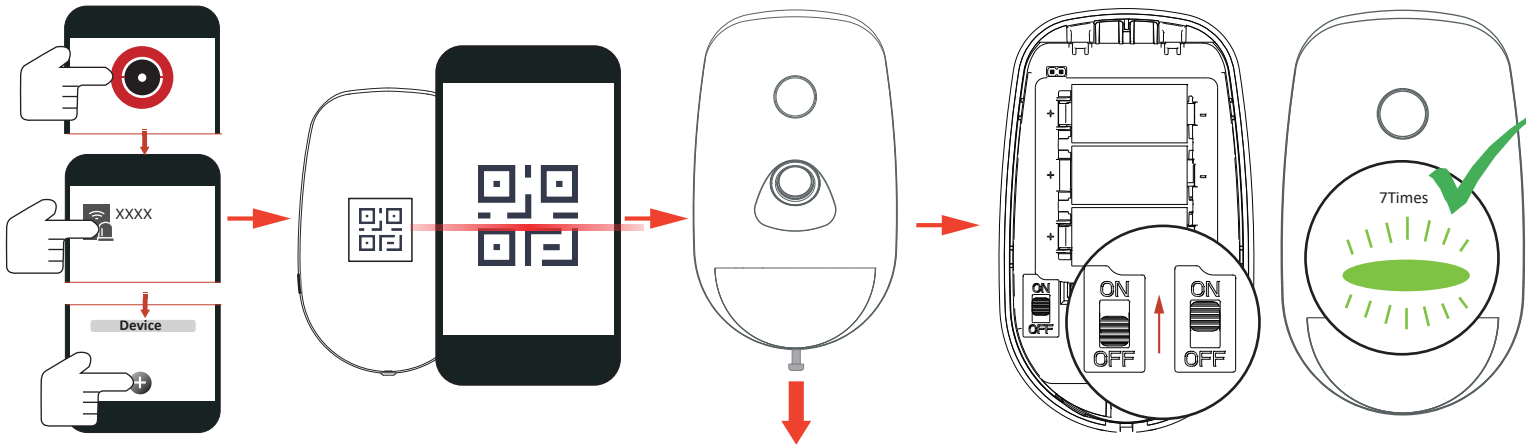

3 Installation

1. Check Signal Strength
Enter the signal checking mode by operating on the control panel. Trigger the detector.
Solid Green for 3 s - Strong Signal
Solid Orange for 3 s - Medium Signal
Solid Red for 3 s - Weak Signal
Red light flashes for 3S - Failure

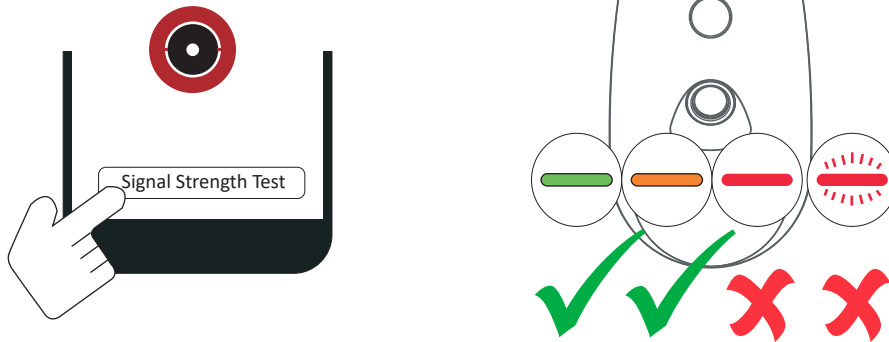

2. Check the installation environment

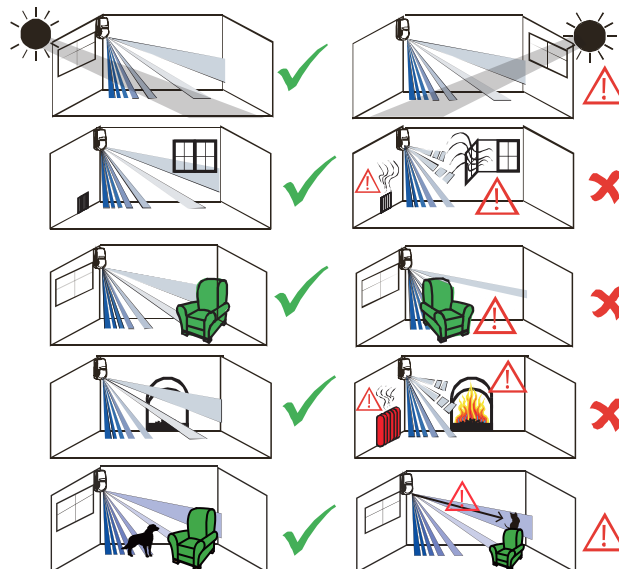

3. Install the Detector

Note: The additional force shall be equal to three times the weight of the equipment but not less than 50N. The equipment and its associated mounting means shall remain secure during the installation. After the installation, the equipment, including any associated mounting plate, shall not be damaged. Make sure there is no obstacle sheltering the LENS and IR light.

with Screws

- a. Knock out the screw holes on the rear panel.

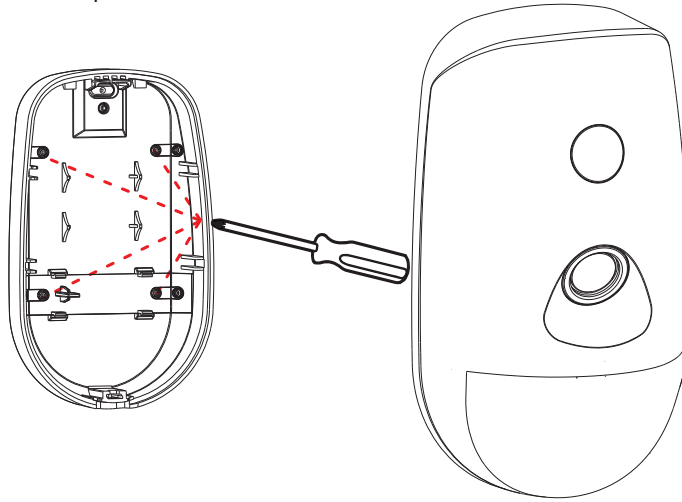

- b. Secure the rear panel on the wall with four screws.

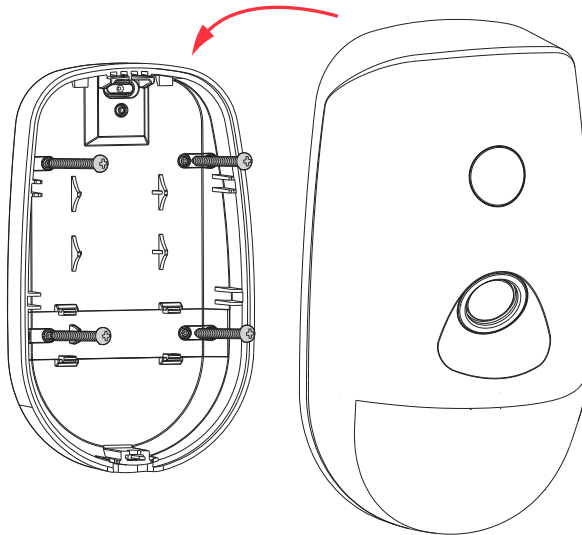

with the Sponge Tape

Paste the device on the wall with sponge tape.
You can paste the detector on the wall or in the corner.

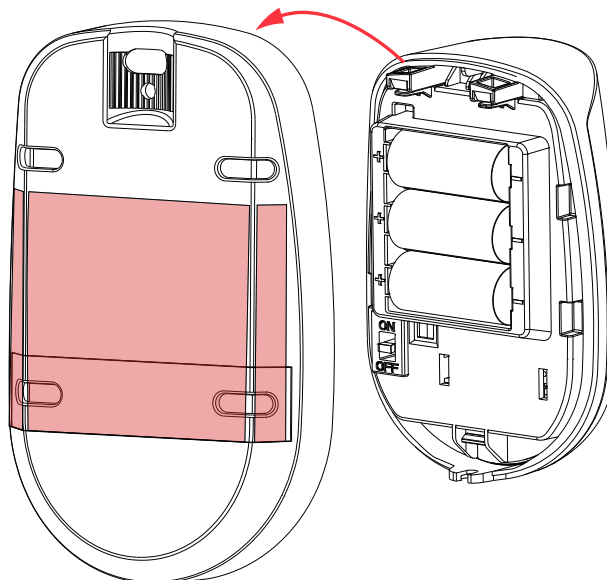

Note: Installing with sponge tape is non EN compliant.

Bracket Installation
Ceiling Bracket Fitting (Non EN compliant)

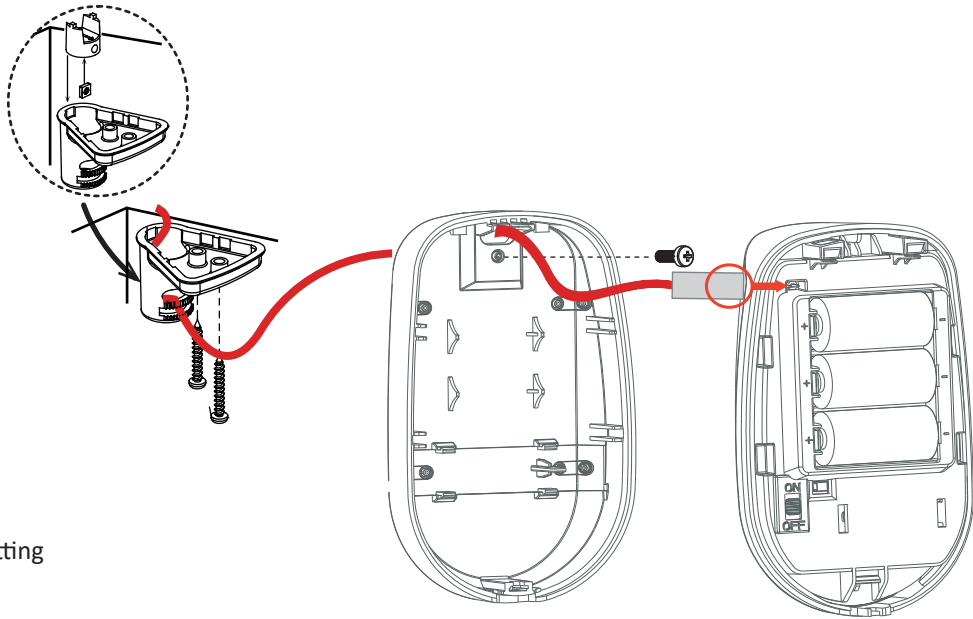

Wall Bracket Fitting

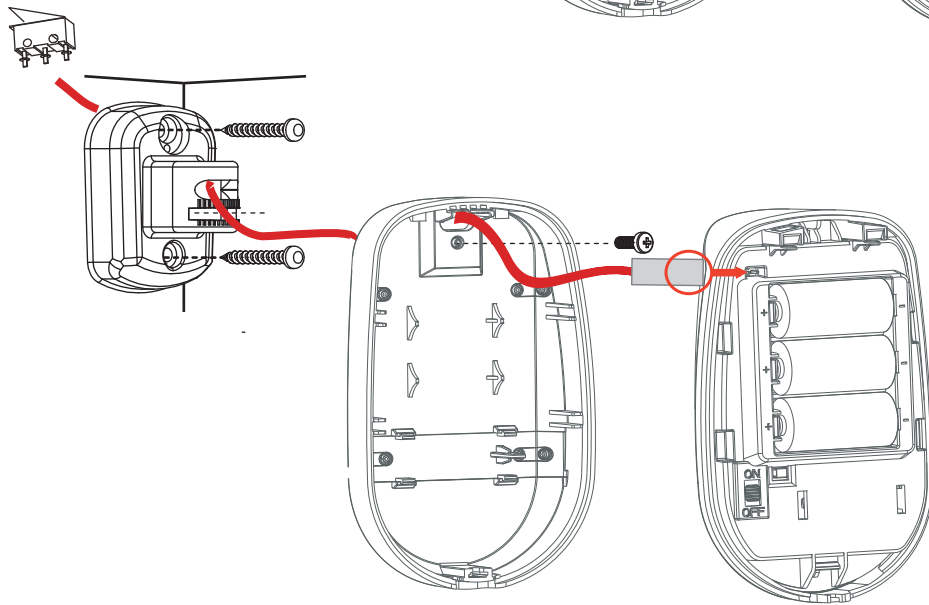

4 Test

Detector zones and planes

The zones and plans of the PIRCAM are shown below.

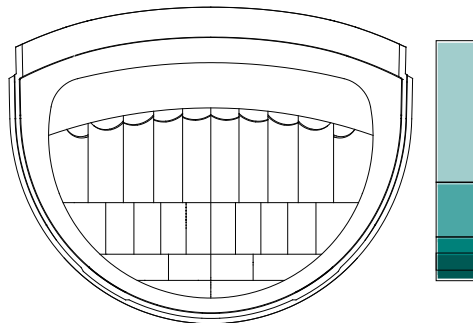
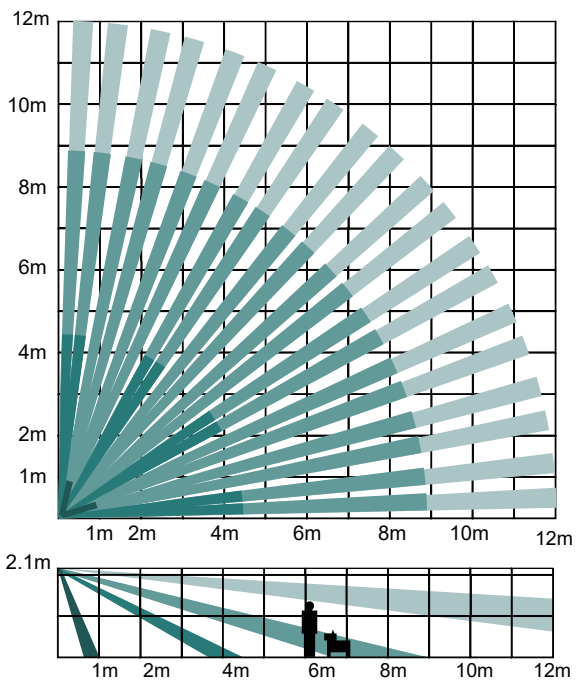

(a) Detection Range
 85.9°
 52 zones
 4 planes

While the detector is disarmed, the detector will enter the walk test mode (within 3 minutes after being enrolled). Trigger the detector within the detection range. If the LED indicator turns blue, the installation position is properly. If the LED indicator is still off, adjust the position of the detector.

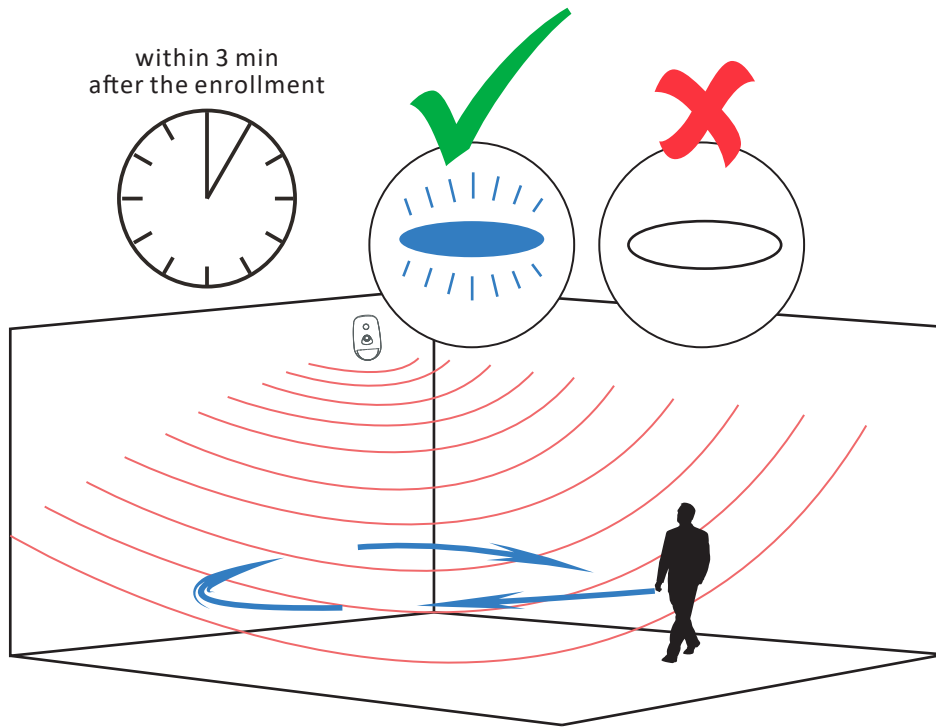

Note: while the detector is disarmed, power off and power on will make the detector enter the walk test mode.

5 Formatting

Hold the tamper switch for 8 s and power the device on at the same time. The red LED flashes 3 times when the formatting operation is completed.

6 Set up with App

Link the detector to the zone.

On the device list page, tap the AX PRO and then log in to the device (if required) to enter the Area page. Tap Device, and tap the zone. You can view the device status including temperature, battery status, signal strength, etc. Tap the  button in the upper right corner to enter the Settings page.

Function	Description
Zone Type	Select the zone type of the detector.
Stay Arm Bypass	Slide to green to bypass the zone from stay arming.
Forbid Bypass on Arming	Slide to green to forbid the zone with fault to be bypassed automatically when arming.
Chime	Slide to green to enable the chime.

Function	Description
Silent Alarm	Slide to green to make the zone keep silent while alarm is triggered.
Sounder Delay Time	Set the delay time. The sounder will be triggered immediately or after the set time.
Cross Zone	If the alarm triggered in both of the linked zones within the set time, two alarm messages will be reported.
Sensitivity	Set the sensitivity of the detector. Higher sensitivity makes the intruder easier to be detected.
Image Resolution	Set the resolution of the image.
Image in Series	Set the captured image number in series.
Swinger limit activations	Set the limit times of swinger activation .
Trigger Interval, sec	Set the interval of trigger, and the alarm message will not be repeated within the time.
LED	Turn On/Off the LED.
Polling Rate	Set the interval of heartbeat.
Signal Strength Test	Enter the test mode, and view the LED indication.
Detection Zone Test	Enter the test mode, and start walk test.
Find Me	Tap Find Me to make peripherals find the zone.
Bypass	Slide to green to bypass the zone.

7 Operation Caution and Device Maintenance

- All the electronic operation should be strictly compliance with the electrical safety regulations, fire prevention regulations and other related regulations in your local region.
 - Do not drop the device or subject it to physical shock, and do not expose it to high electromagnetism radiation. Avoid the equipment installation on vibrations surface or places subject to shock (ignorance can cause equipment damage).
 - Please make sure that the power has been disconnected before you wire, install or dismantle the device.
 - If smoke, odors or noise rise from the device, turn off the power at once and unplug the power cable, and then please contact the service center.
 - Do not drop the device or subject it to physical shock, and do not expose it to high electromagnetism radiation. Avoid the equipment installation on vibrations surface or places subject to shock (ignorance can cause equipment damage).
 - Do not place the device in extremely hot (refer to the specification of the device for the detailed operation temperature), cold, dusty or damp locations, and do not expose it to high electromagnetic radiation.
 - The device for indoor use shall be kept from rain and moisture.
- Exposing the equipment to direct sun light, low ventilation or heat source such as heater or radiator is forbidden (ignorance can cause fire danger).
- Do not aim the device at the sun or extra bright places. A blooming or smear may occur otherwise (which is not a malfunction however), and affecting the endurance of sensor at the same time.
 - Improper use or replacement of the battery may result in hazard of explosion. Replace with the same or equivalent type only. Dispose of used batteries according to the instructions provided by the battery manufacturer.
 - Do not expose the device to the corrosive gas. Otherwise the equipment damage may occur.
 - Do not expose the device to the explosive situation.

8 Specification

	Model	DS-PDPC12PF-EG2-WB/WE
Detection Performance	Detection Method	Passive Infrared,Video Verification
	Sensor Model	SFG321-711
	Detection Range	12m
	Detection Angle	85.9°
	Detection Zones	52
	Detectable Speed	0.3 to 2m/s
	Sensitivity	Auto,High,Pet
	Pet Immunity	30Kg
	White Light Filter	6500lux
	Digital Temperature Compensation	Support
	Creep Zone Protection	Support
Feature	Digital Processing	Support
	Sealed Optics	Support
	Tamper Protection	Front,Rear
	Environment Temperature Indicator	Support
	Signal Strength Indicator	Support
Video	Image Sensor	ASX340
	Field Angle	88°(H), 68°(V)
	Image Type	JPEG
	Resolution	640*480,320*240,160*120
	Frame Rate	2
	Fill Light	White Light
	Fill Range	12m
Day/Night Switch		Color
Interface	Power Switch	Power Up Enrolling
	LED Indicator	Blue(Alarm)
Transmission	Transmission Technology	CAM-X Wireless
	Transmission Method	Two-Way RF Wireless
	Transmission Frequency	433MHz/868MHz
	Transmission Security	AES-128 Encryption
	Transmission Range(Free Space)	800m
Enrolling Method	Power up,Remote ID,QR Code	
Electrical Characteristics	Power Supply	Battery Powered
	Battery Type	CR123A × 3
	Typical Voltage	3V
	Low Voltage Value	2.45 V
	Consumption	Max. current: 1.5A Quiescent current: 10uA
	PS Type	Type C
	Standard Battery Life	6 Years
General	Operation Temperature	-10 °C to 55 °C (14 °F to 131 °F)
	Storage Temperature	-20 °C to 60 °C (-4 °F to 140 °F)
	Operation Humidity	10% to 90%
	Dimension(WxHxD)	72.2mm × 120.5mm × 56.7mm
	Weight	220g
	Mounting Height	1.8 to 2.4m
	Mounting Method	Wall
	Application Scenario	Indoor
Bracket	Optional Wall & Ceiling Accessory	

9 Reference Table

1st Photo transmission time	
- 160 x 120	5s (5KB per image)
- 320 x 240	6s (10KB per image)
- 640 x 480	12s (60KB per image)
Internal memory buffer	
- 160 x 120	160 images (5KB per image)
- 320 x 240	80 images (10KB per image)
- 640 x 480	25 images (30KB per image)