

COPYRIGHT © Hangzhou EZVIZ Software Co., Ltd. ALL RIGHTS RESERVED.

Any and all information, including, among others, wordings, pictures, graphs are the properties of Hangzhou EZVIZ Software Co., Ltd. (hereinafter referred to as “EZVIZ”). This user manual (hereinafter referred to as “the Manual”) cannot be reproduced, changed, translated, or distributed, partially or wholly, by any means, without the prior written permission of EZVIZ. Unless otherwise stipulated, EZVIZ does not make any warranties, guarantees or representations, express or implied, regarding to the Manual.

About this Manual

The Manual includes instructions for using and managing the product. Pictures, charts, images and all other information hereinafter are for description and explanation only. The information contained in the Manual is subject to change, without notice, due to firmware updates or other reasons. Please find the latest version in the EZVIZ™ website (<http://www.ezviz.com>).

Revision Record

New release – January, 2022

Trademarks Acknowledgement

EZVIZ™, ™, and other EZVIZ's trademarks and logos are the properties of EZVIZ in various jurisdictions. Other trademarks and logos mentioned below are the properties of their respective owners.

Legal Disclaimer

TO THE MAXIMUM EXTENT PERMITTED BY APPLICABLE LAW, THE PRODUCT DESCRIBED, WITH ITS HARDWARE, SOFTWARE AND FIRMWARE, IS PROVIDED “AS IS”, WITH ALL FAULTS AND ERRORS, AND EZVIZ MAKES NO WARRANTIES, EXPRESS OR IMPLIED, INCLUDING WITHOUT LIMITATION, MERCHANTABILITY, SATISFACTORY QUALITY, FITNESS FOR A PARTICULAR PURPOSE, AND NON-INFRINGEMENT OF THIRD PARTY. IN NO EVENT WILL EZVIZ, ITS DIRECTORS, OFFICERS, EMPLOYEES, OR AGENTS BE LIABLE TO YOU FOR ANY SPECIAL, CONSEQUENTIAL, INCIDENTAL, OR INDIRECT DAMAGES, INCLUDING, AMONG OTHERS, DAMAGES FOR LOSS OF BUSINESS PROFITS, BUSINESS INTERRUPTION, OR LOSS OF DATA OR DOCUMENTATION, IN CONNECTION WITH THE USE OF THIS PRODUCT, EVEN IF EZVIZ HAS BEEN ADVISED OF THE POSSIBILITY OF SUCH DAMAGES.

TO THE MAXIMUM EXTENT PERMITTED BY APPLICABLE LAW, IN NO EVENT SHALL EZVIZ'S TOTAL LIABILITY FOR ALL DAMAGES EXCEED THE ORIGINAL PURCHASE PRICE OF THE PRODUCT.

EZVIZ DOES NOT UNDERTAKE ANY LIABILITY FOR PERSONAL INJURY OR PROPERTY DAMAGE AS THE RESULT OF PRODUCT INTERRUPTION OR SERVICE TERMINATION CAUSED BY: A) IMPROPER INSTALLATION OR USAGE OTHER THAN AS REQUESTED; B) THE PROTECTION OF NATIONAL OR PUBLIC INTERESTS; C) FORCE MAJEURE; D) YOURSELF OR THE THIRD PARTY, INCLUDING WITHOUT LIMITATION, USING ANY THIRD PARTY'S PRODUCTS, SOFTWARE, APPLICATIONS, AND AMONG OTHERS.

REGARDING TO THE PRODUCT WITH INTERNET ACCESS, THE USE OF PRODUCT SHALL BE WHOLLY AT YOUR OWN RISKS. EZVIZ SHALL NOT TAKE ANY RESPONSIBILITIES FOR ABNORMAL OPERATION, PRIVACY LEAKAGE OR OTHER DAMAGES RESULTING FROM CYBER ATTACK, HACKER ATTACK, VIRUS INSPECTION, OR OTHER INTERNET SECURITY RISKS; HOWEVER, EZVIZ WILL PROVIDE TIMELY TECHNICAL SUPPORT IF REQUIRED. SURVEILLANCE LAWS AND DATA PROTECTION LAWS VARY BY JURISDICTION. PLEASE CHECK ALL RELEVANT LAWS IN YOUR JURISDICTION BEFORE USING THIS PRODUCT IN ORDER TO ENSURE THAT YOUR USE CONFORMS TO THE APPLICABLE LAW. EZVIZ SHALL NOT BE LIABLE IN THE EVENT THAT THIS PRODUCT IS USED WITH ILLEGITIMATE PURPOSES.

IN THE EVENT OF ANY CONFLICTS BETWEEN THE ABOVE AND THE APPLICABLE LAW, THE LATTER PREVAILS.

Table of Contents

Instruction	1
Packing List	1
Overview	2
1. Lock	2
2. Door Sensor	3
Get the EZVIZ App	3
Installation Instructions	4
1. Install Mounting Plate	5
2. Insert the Key into the Lock	7
3. Mount the Lock Body	8
4. Instert Batteries	8
Add Lock to EZVIZ	9
1. Add Lock to EZVIZ	9
2. Calibrate the Lock	10
3. Install the Door Sensor	11
4. Installation Complete	12
Bluetooth Key Management	13
1. Add Bluetooth Keys	13
2. Manage Bluetooth Keys	13
Accessory Management	13
1. Add Accessory	13
2. Manage Accessory	14
Card and Password Management	14
1. For Password Keypad	14
2. For Card-password Keypad	14
Lock Using	14
1. Unlock	14
2. Lock	15
3. Operation and Management	15
Maintenance	16
1. Daily Maintenance	16
2. FAQ	16
Operations on the EZVIZ App	18

Instruction

- The installation of EZVIZ Smart Lock (hereinafter referred as to "lock") impacts its normal operation and service life. It is recommended to let professionals install.
- The lock is designed for indoor use only.
- It is recommended to remove the lock if your house is under decoration, and reinstall it after decoration in case of lock damage and service life reduction.
- Please note that disinfectant may cause damage to the lock body.
- When battery voltage is low after using for a while, low voltage alarm alerts. Replace batteries timely and pay attention to positive and negative poles.
- If you leave home or do not use lock for a long time, you should take batteries out to ensure lock service life.
- The lock accommodates up to 50 bluetooth keys, 50 passwords and 50 cards.

Packing List



Smart Lock ×1

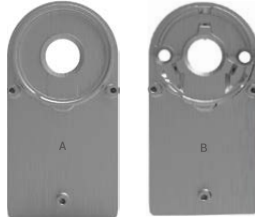

Mounting Plate ×2

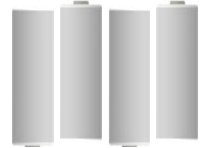

AA-sized Battery ×4



Hexagon Wrench ×1



Plus Driver ×1



Screw Kit ×1



Door Sensor ×1



Quick Start Guide ×1

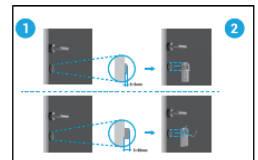

Installation Guide ×1







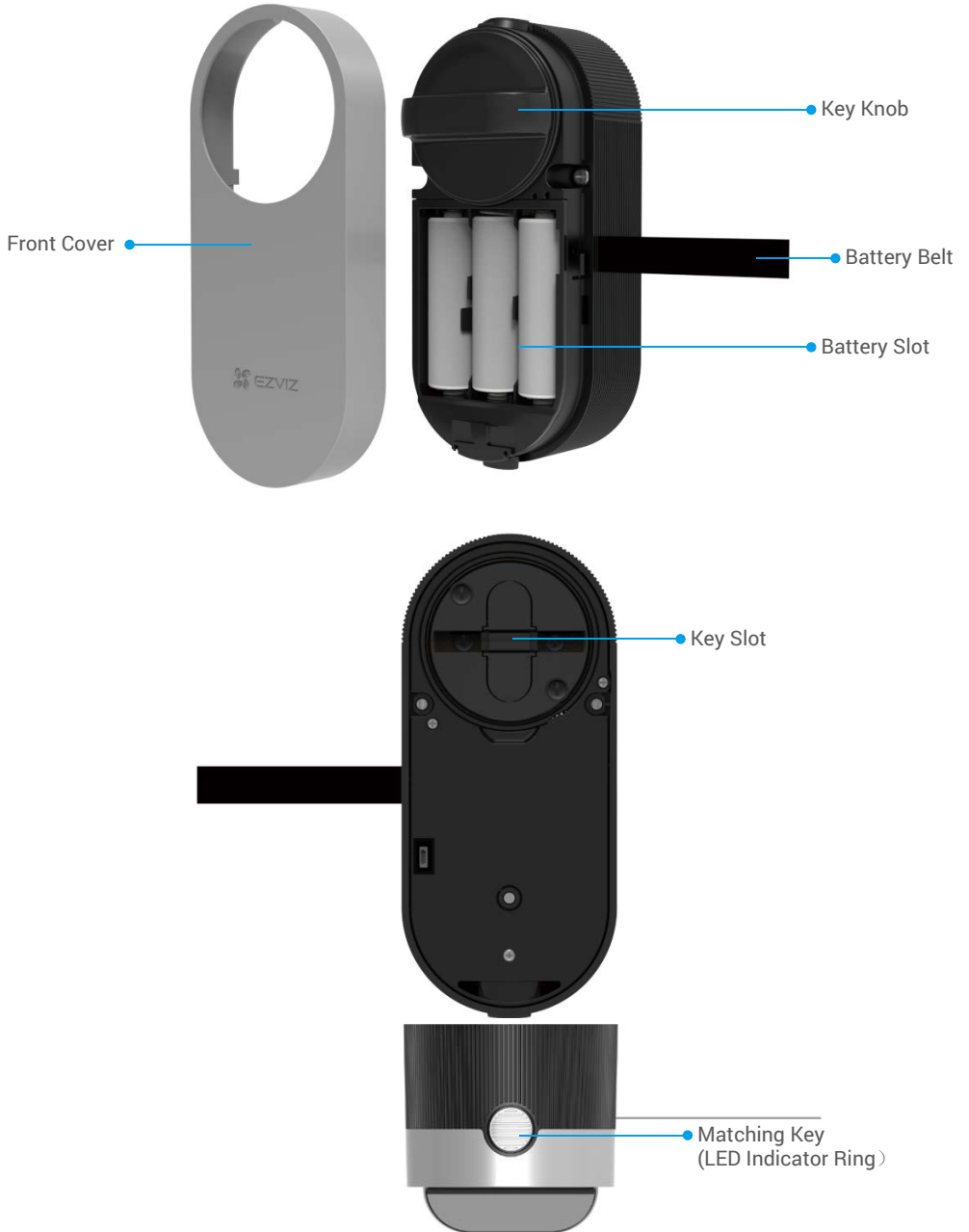

Regulatory Information ×1

Overview

1. Lock



Name	Description
Battery Belt	<ul style="list-style-type: none"> Put the belt under the batteries when you insert the batteries into the slot; When you need to change batteries, drag the belt and the batteries will pop out.
Matching Key	<ul style="list-style-type: none"> Press once, the lock will be locked/unlocked. In initialization condition, press and hold for 3s to add to EZVIZ App. Press and hold for 3s to enter adding mode. Repower the lock, press and hold the Matching Key for 5s until the LED indicator ring is solid orange, all parameters will be restored to default settings.
LED Indicator Ring	<ul style="list-style-type: none">  Solid Orange: Door unlocked or initialization status.  Slow-flashing Orange: Unlock failed.  Fast-flashing Orange: Initializing.  Solid Blue: Locked, calibrated successfully, or added to EZVIZ successfully.  Slow-flashing Blue: Unlock successfully.  Fast-flashing Blue: Adding mode or calibrating.

-  The LED will flash only when you are operating the lock.
- In general the lock is in sleep mode and the LED will be off.

2. Door Sensor

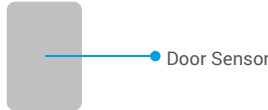

Get the EZVIZ App

1. Connect your mobile phone to Wi-Fi (suggested).
2. Download and install the EZVIZ app by searching for “EZVIZ” in the App Store or Google Play™.
3. Launch the app and register an EZVIZ user account.

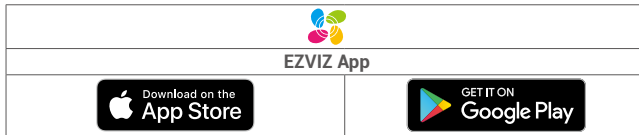

-  If you have already used the app, please make sure that it is the latest version. To find out if an update is available, go to the app store and search for “EZVIZ”.

Installation Instructions

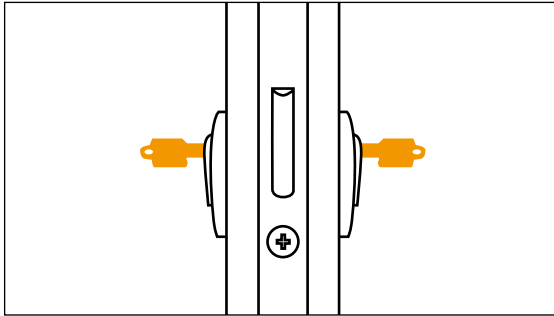

i Make sure your existing lock allows you to fully insert the keys from both sides to unlock.

Please tap  to watch the installation video.



1. Install Mounting Plate

The lock is mounted on the inside of the existing lock cylinder. There are two different types of mounting plates to choose depending on your cylinder.

Mounting Plate A

Cylinder with less than 3mm overhang on the inside of the door. The lock is glued to your door with special adhesive pads.

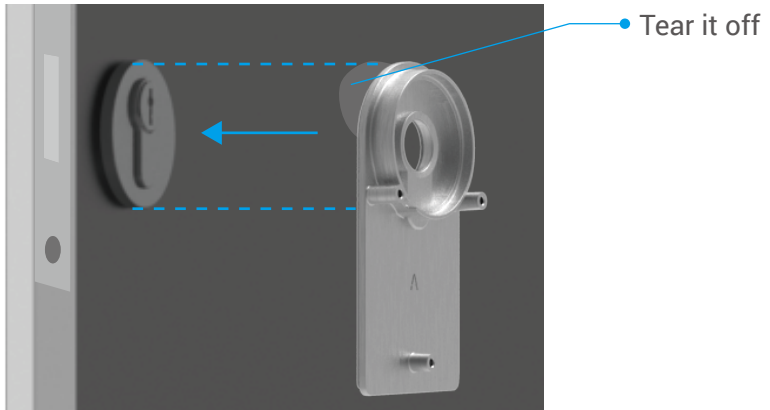
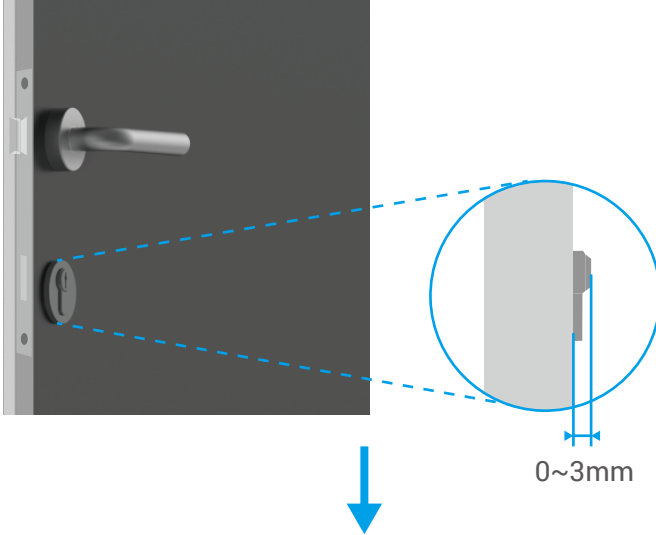

Mounting Plate B

Cylinder with at least 3mm overhang on the inside of the door : fix the mounting plate B to the cylinder with screws by the supplied hexagon wrench. Please fix the screws carefully and without great physical effort to avoid damaging the cylinder.

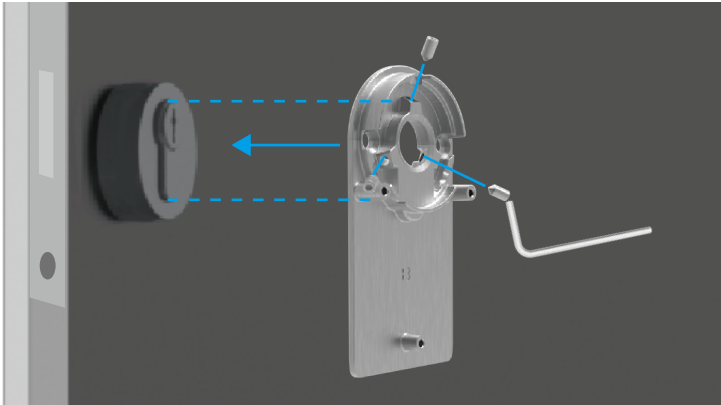
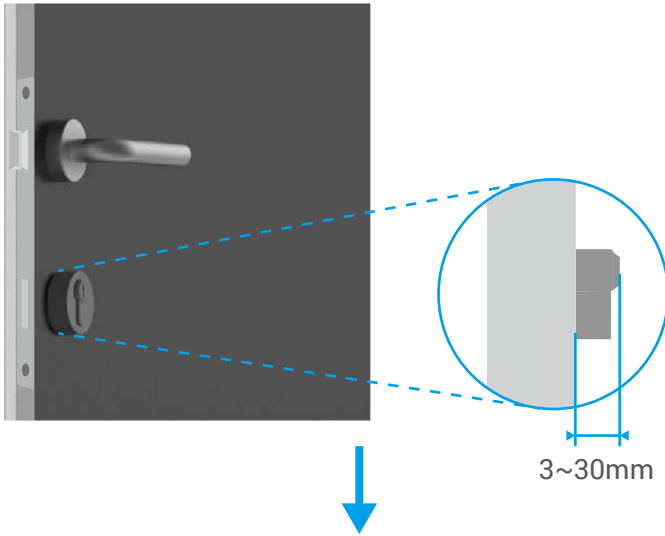

2. Insert the Key into the Lock

The lock is supposed to enable keyless door opening. For lock to be compatible with the key, the following conditions must apply:

- The key must not be thicker than 4 mm.
- The length of the key head including the neck must be less than 37 mm for lock to be compatible (The key head is the part of the key which people opening the door grasps. The following part of the key head up to the reliefs is called the neck).
- If a plastic cap is attached to the key, making the key thicker than 4 mm overall, it must be removed. This cap increases the thickness of the key, making the bow no longer fit into the lock.

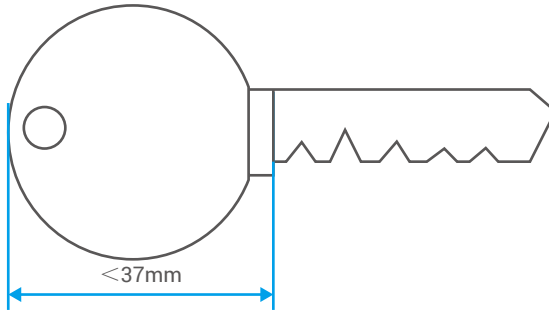

- i** The shape of the key head does not matter at all. It may be round, angular or oval.

Insert your key to the keyhole as showed below (take Mounting Plate A for example):

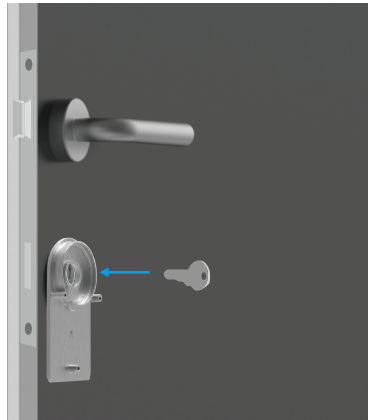

3. Mount the Lock Body

Attach the lock body to the mounting plate with three screws (PM3×16) by the supplied plus driver, (take Mounting Plate A for example).

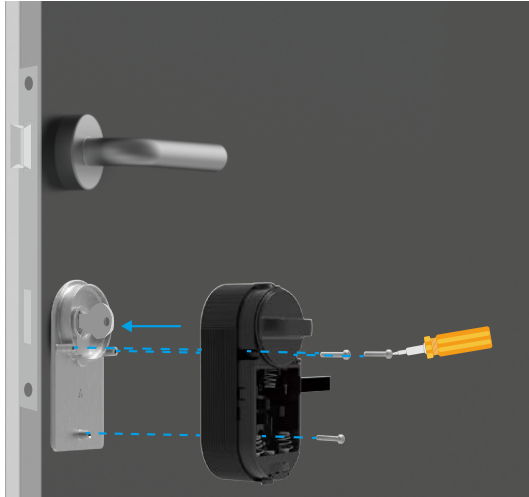

4. Insert Batteries

Insert 4 AA-sized batteries into the slot. Please pay attention to positive and negative poles when insert the batteries. Make sure the battery belt is on the bottom of the slot under the batteries.



i Put the front cover aside for further use.

Add Lock to EZVIZ

i The app interface may be different due to version update, and the interface of the app you installed on your phone shall prevail.

1. Add Lock to EZVIZ

1. Log in to your account through EZVIZ app, tap the device adding icon and then the QR code scanning interface will be displayed.

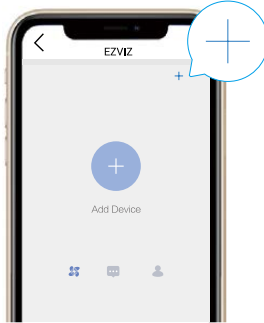

2. Scan the QR code on the back of the front cover.



3. Press and hold the **Matching Key** of lock for 3 seconds after you hear 'Di'. When the indicator ring is fast flashing blue, the bluetooth is enabled and the lock enters adding mode which will last 3 minutes.

i During adding configuration EZVIZ may ask for the bluetooth permission includes the scanning, adding and using bluetooth devices. Please click Yes to grant this permission.

4. Put your cellphone close to the lock. Enter the six-digits management code when needed. The management code is on the back of the front cover.



- For your privacy security, it is recommended to change management code after the adding configuration.
- It is recommended to save the management code to your phone. Enable it, the code will be saved for automatic verification of bluetooth keys, cards, passwords so manual input is not required.
- Please reverify the management code if you have changed your phone.

5. Complete adding the lock to EZVIZ by following the wizard on the app.

2. Calibrate the Lock

Automatic Calibration

After adding the lock to EZVIZ, you need to calibrate the installation state according to the wizard on the page.

1. Please open the door and keep the lock tongue retracted and click the Next Step.

- Please do not turn off or operate the lock under automatic calibration.

2. Please wait patiently while lock is under automatic calibration.

The calibration is complete when lock tongue keeps retracted and the LED indicator ring flashes solid blue.

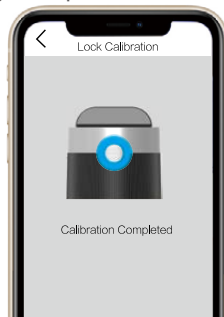

3. Please check the status of the lock tongue.

If the tongue is not retracted, please recalibrate or enter manual calibration mode which is more precise.

Manual Calibration

Please follow the wizard on the page and complete the calibration manually.

1. Check out your lock and confirm it is locked or unlocked when the door lock knob turned clockwise.

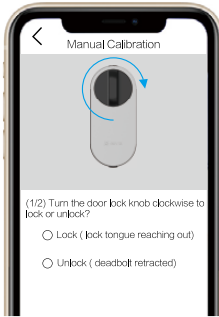

2. Turn the key knob and record the number of turns does it need to unlock (lock tongue retracted).

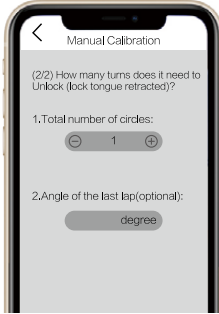

3. Install the Door Sensor

Please install the door sensor according to the wizard on the page.

1. Please stand inside the door and attach the door sensor to the door frame and close to the lock. Please note that the center of the door sensor should be parallel to EZVIZ logo on the cover, as shown in the figure below. The distance between the door sensor and the lock can't exceed 5cm.

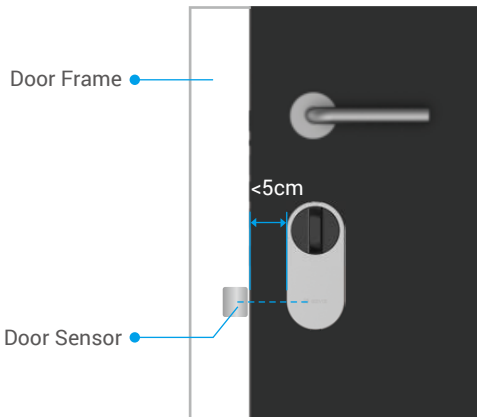

Front View

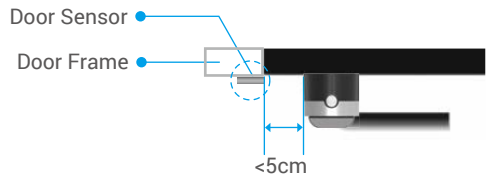

Top View

- ① If your door protrudes beyond the door frame, it is recommended to attach the door sensor on the other side of the door frame. Please note that the center of the door sensor should be parallel to EZVIZ logo on the cover, as shown in the figure below. The distance between the door sensor and the lock can't exceed 5cm.

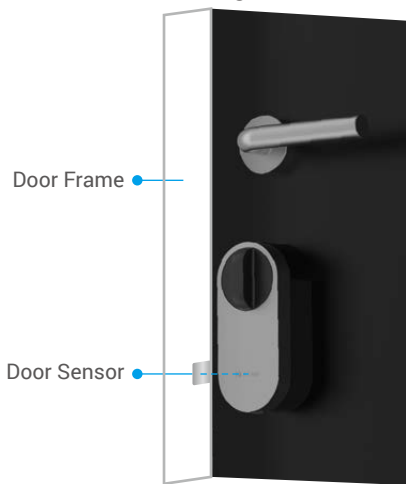

Side View

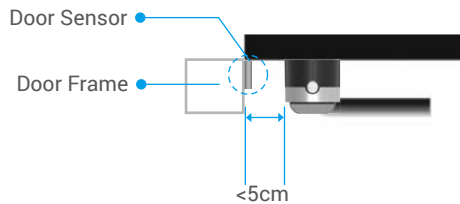

Top View

2. Please calibrate the door sensor according to the tips on the page. The door lock will record 3 different states of the door sensor and will judge if the door is open or closed accordingly.

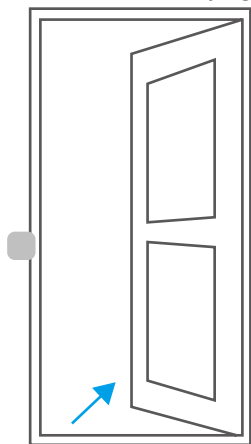

Open

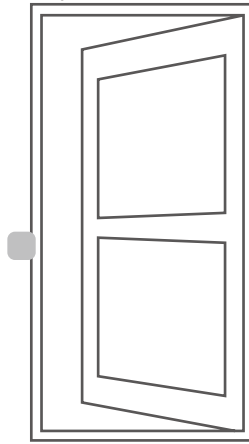

Ajar

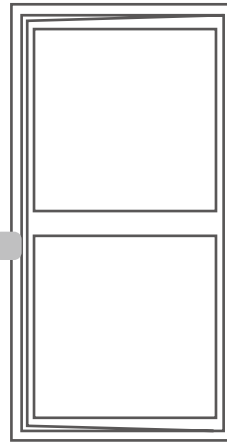

Close

4. Installation Complete

- ① • If you have already bought the accessory of the keypad, please click and bind the accessory. For detailed information, please refer to **Chapter Accessory Management**.
• If you have no accessory of the keypad, the installation of lock is completed.

After the installation complete, you can unlock the door on the EZVIZ app from outside the door. Launch the EZVIZ app, tap your lock and slide right to unlock as shown below.

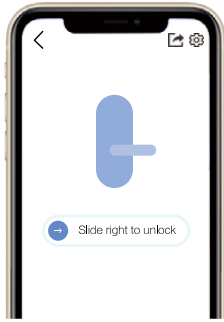

Bluetooth Key Management

1. Add Bluetooth Keys

Add bluetooth keys for your family or guests, they can also unlock the door on the EZVIZ app.

The following conditions are required:

1. Make sure your family or guests have installed and logged onto the APP.
2. Operate on the Ezviz App near the lock.

Follow the steps below yourself:

1. Click Bluetooth key management and Add bluetooth keys, enter the EZVIZ account of your family or guests.
2. Set the name of your family or guests, and click Next Step.
3. Set the term of validity and click Next Step.
4. Obtain the bluetooth matching code and inform your family or guests of the code.

Assist your family or guests to complete the following operation.

1. Family or guests receive the device on their phones.
2. Refresh the homepage, find the lock card and click to get in.
3. Put the phone of your family or guests close to the lock, enter the bluetooth matching code for verification. After verification, the phone can be successfully bound and the unlocking function is supported on the phone.

- Please put the phone close to the lock and make sure the phone is bluetooth connected to the lock.
- Please make sure the management code is correct.
- Retry from step 1.

2. Manage Bluetooth Keys

Launch your EZVIZ app within bluetooth range and make sure your phone is bluetooth connected to the lock. Click More button behind their name, you can set term of validity and delete their bluetooth key.

Accessory Management

Please purchase password keypad or card-password keypad separately.

1. Add Accessory

The lock is able to bind only one password keypad or card-password keypad. The progress are the same.

1. Press and hold the anti prying key, then you put batteries in the battery slot. Otherwise you have to silence the

- alarm on the EZVIZ app after you bind the keypad to the lock.
2. Launch your EZVIZ app within bluetooth range and make sure your phone is bluetooth connected to the lock.
 3. Tap your lock and choose Settings -> Accessory Management and choose the type of your accessory. Here we take password keypad as an example.
 4. Press and hold the Confirm Key for 3s until the LED indicator ring is flashing blue, the keypad is ready for binding to the lock.

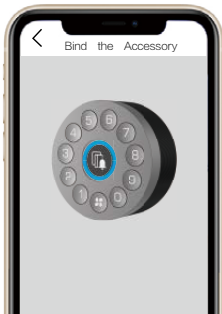

5. Add the keypad by following the wizard on the app.
The EZVIZ app will automatically enter keypad page when the accessory is bound successfully.

- Please make sure that the accessory are close to the lock if binding failed.
- Retry from step 1 if binding failed.

2. Manage Accessory

Launch your EZVIZ app within bluetooth range and make sure your phone is bluetooth connected to the lock. Tap your lock and choose Setting -> Accessory Management, you can manage passwords (for detailed information, please refer to **Chapter Card and Password Management**), unbind and upgrade the keypad on this page.

Card and Password Management

1. For Password Keypad

Launch your EZVIZ app within bluetooth range and make sure your phone is bluetooth connected to the lock. Tap your lock and choose Setting -> Accessory Management -> Password Management, you can manage passwords by following the wizard on the app.

2. For Card-password Keypad

Launch your EZVIZ app within bluetooth range and make sure your phone is bluetooth connected to the lock. Tap your lock and choose Setting -> Accessory Management -> Card and password management, you can manage passwords and cards by following the wizard on the app.

- For your privacy security, please keep cards along with you.

Lock Using

1. Unlock

Indoor Unlock

Press the Matching Key of the lock, when the LED turning fast-flashing blue and solid orange indicates that the lock is unlocked.

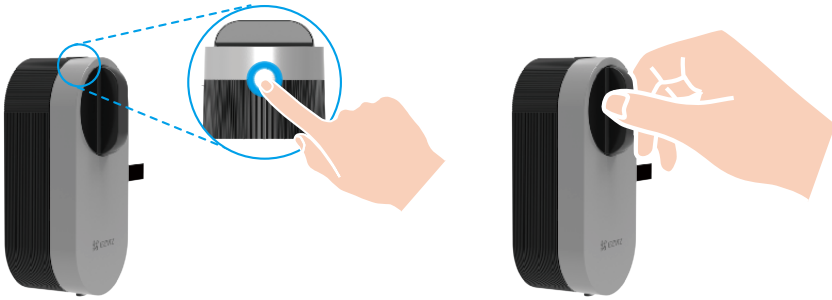

Outdoor Unlock



App Unlock



Password Unlock



Card Unlock

① Card/password unlock requires the using of the accessory (sold seperately).

2. Lock

Indoor Lock

Press the Matching Key of the lock, when the LED turning solid blue indicates that the lock is locked.

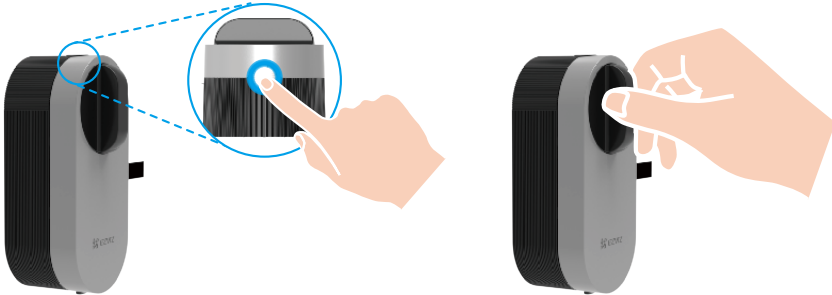

Outdoor Lock



Auto Lock



App Lock



Timed Lock

① Auto lock requires the using of door sensor. For detailed information, please refer to **Chapter Add Lock to EZVIZ -> Install the Door Sensor**.

3. Operation and Management

Bluetooth connection mode

In consideration of quick reponse and power consumption, the lock provides 3 different bluetooth connection modes. You can adjust it as you need on the app.

1. Launch your EZVIZ app within bluetooth range and make sure your phone is bluetooth connected to the lock.
2. Tap your lock and choose Setting -> Bluetooth Connection Mode and set the mood you need.

Install Batteries

Install batteries: press the button on the bottom and remove the front cover, drag the belt and the batteries will pop out. Install 4*AA-sized batteries into the slot, and then press battery cover.



- Install correct batteries in case of explosion.
- When not using batteries for a long time, remove them from battery slot.
- Do not use new batteries with old ones at the same time.
- Do not place batteries with the (+) and (-) in the wrong way around.
- Dispose used batteries according to the local environmental protection law.

Restore to Factory Settings

Repower the lock, press and hold the Matching Key for 5s until the LED indicator ring is solid orange, all parameters will be restored to default settings.

Alarms

1. Tamper Alarm

Once being dismantled by force, the lock will send out alarm lasting about one minute.

2. System Locked Alarm

Verify with wrong password or card 5 times in 5 minutes, the system will be locked for 3 minutes.

3. Low Voltage Alarm

Once battery voltage is low, the voice prompt will remind you to replace batteries.

Maintenance

1. Daily Maintenance

- Do not let lock contact with corrosive materials to avoid lock damage and impacting its gloss.
- Replace batteries immediately once battery voltage is low to ensure the normal use of the lock. Pay attention to the positive and negative poles of batteries when replacing them.
- Ask professionals to check the lock if it is not flexible or cannot be held in correct position.
- Keep lubricant in the rotating part of the lock to keep it rotate smoothly and prolong its service life.
- It is recommended to check the lock once every six months or one year, and check whether the key is loose.
- Apply a small amount of graphite powder or pencil powder into lock cylinder slot to ensure the key is inserted and removed smoothly on regular basis (one year or six months). However, do not apply any grease to lubricate in case of grease sticking to the pin tumbler spring.

2. FAQ

Problem	Cause	Solution
Door cannot be opened successfully through verifications by bluetooth key, app, password or card.	Lock installation problem.	Ask professionals to check the lock.
	The distance between lock and accessory is too far.	Please make sure that the accessory are close to the lock.
	The battery is low.	Replace the batteries of lock or accessory.
	Bluetooth key has expired.	Use another opening method.
	Password or card has expired.	
Verified by password and card successfully, but motor doesn't work, and door cannot be opened.	The mechanical key inside the lock is at fault.	Check the lock, and replace damaged components.
	Motor fault.	
No response of keypad.	Batteries are out of power or installed in a wrong way.	Unlock the lock through app or mechanical key, and check batteries.
	Keypad damaged.	Ask professionals to check the lock after opening door with mechanical key.
The lock remains open, and cannot be used normally.	Clutch components fault.	Ask professionals to check the lock.
	The door sensor doesn't work properly.	Calibrate the door sensor again.

For additional information about the device, please refer to www.ezviz.com.

Operations on the EZVIZ App

i The app interface may be different due to version update, and the interface of the app you installed on your phone shall prevail.

When you launch the EZVIZ app and tap your lock, you can view and manage the lock as needed on the homepage.

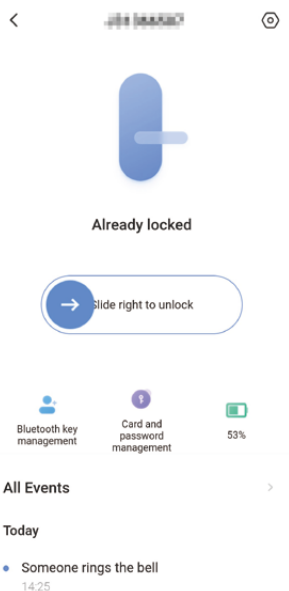

	Slide right to unlock.
Bluetooth key management	Click to manage the bluetooth keys for your family or your guests.
Card and password management	Click to manage the cards and passwords for the lock.
Battery storage	Check to the storage of the battery of the lock.
All Events	Check all events happened to the lock.