

Ethernet Switch

Web Operation Manual







Foreword

General

This manual introduces operations on web interface of the Ethernet Switch (hereinafter referred to as "the Switch"). You can visit the switch on web browser, configure and manage the switch.

Safety Instructions

The following categorized signal words with defined meaning might appear in the manual.

| Signal Words | Meaning |
|---|---|
|  DANGER | Indicates a high potential hazard which, if not avoided, will result in death or serious injury. |
|  WARNING | Indicates a medium or low potential hazard which, if not avoided, could result in slight or moderate injury. |
|  CAUTION | Indicates a potential risk which, if not avoided, could result in property damage, data loss, lower performance, or unpredictable result. |
|  TIPS | Provides methods to help you solve a problem or save you time. |
|  NOTE | Provides additional information as the emphasis and supplement to the text. |

Revision History

| Version | Revision Content | Release Time |
|---------|------------------|--------------|
| V1.0.0 | First release. | April 2021 |

About the Manual

- The manual is for reference only. If there is inconsistency between the manual and the actual product, the actual product shall prevail.
- We are not liable for any loss caused by the operations that do not comply with the manual.
- The manual would be updated according to the latest laws and regulations of related regions. For detailed information, see the paper manual, CD-ROM, QR code or our official website. If there is inconsistency between paper manual and the electronic version, the electronic version shall prevail.
- All the designs and software are subject to change without prior written notice. The product updates might cause some differences between the actual product and the manual. Please contact the customer service for the latest program and supplementary documentation.
- There still might be deviation in technical data, functions and operations description, or errors in print. If there is any doubt or dispute, please refer to our final explanation.

- Upgrade the reader software or try other mainstream reader software if the manual (in PDF format) cannot be opened.
- All trademarks, registered trademarks and the company names in the manual are the properties of their respective owners.
- Please visit our website, contact the supplier or customer service if there is any problem occurred when using the device.
- If there is any uncertainty or controversy, please refer to our final explanation.

Important Safeguards and Warnings

The manual helps you to use our product properly. To avoid danger and property damage, read the manual carefully before using the product, and we highly recommend you to keep it well for future reference.

Operating Requirements

- Do not expose the device directly to the sunlight, and keep it away from heat source.
- Do not install the device in the damp environment, and avoid dust and soot.
- Make sure the device is in horizontal installation, and install the device on solid and flat surface to avoid falling down.
- Avoid liquid spattering on the device. Do not place object full of liquid on the device to avoid liquid flowing into the device.
- Install the device in the well-ventilated environment. Do not block the air vent of the device.
- Use the device at rated input and output voltage.
- Do not disassemble the device without professional instruction.
- Transport, use, and store the device in allowed ranges of humidity and temperature.
- When removing the cable, power off the device first to avoid personal injury.
- Voltage stabilizer and lightning protection device are optional according to power supply and surrounding environment.

Power Supply Requirements

- Use the battery properly to avoid fire, explosion, and other dangers.
- Replace the battery with battery of the same type.
- Use locally recommended power cord in the limit of rated specifications.
- Use the standard power adapter. We will assume no responsibility for any problems caused by nonstandard power adapter.
- The power supply shall meet the SELV requirement. Use the power supply that conforms to Limited Power Source, according to IEC62368-1. Refer to the device label.
- Be sure to ground the device (cross section of copper wire: $> 2.5 \text{ mm}^2$; resistance to ground: $\leq 4 \Omega$).
- The coupler is the disconnecting apparatus. Keep it at the angle for easy operation.

Table of Contents

| | |
|--|------------|
| Foreword | I |
| Important Safeguards and Warnings | III |
| 1 Login | 1 |
| 2 Quick Settings | 2 |
| 2.1 System Information..... | 2 |
| 2.2 Local | 3 |
| 2.3 VLAN | 4 |
| 2.4 Aggregation | 5 |
| 2.4.1 Static Aggregation Configuration | 5 |
| 2.4.2 Dynamic Aggregation Configuration | 6 |
| 2.5 IP and Route | 6 |
| 3 Advanced Settings | 9 |
| 3.1 Common Configuration | 9 |
| 3.1.1 System Configuration..... | 9 |
| 3.1.2 Port Configuration | 14 |
| 3.1.3 VLAN Configuration | 16 |
| 3.1.4 Aggregation | 17 |
| 3.1.5 MAC Table | 19 |
| 3.1.6 Spanning Tree..... | 23 |
| 3.1.7 Long Distance PoE | 26 |
| 3.2 Seldom-used Configurations..... | 26 |
| 3.2.1 ERPS..... | 26 |
| 3.2.2 ACL | 33 |
| 3.2.3 Loop Protection | 35 |
| 3.2.4 Security | 36 |
| 3.2.5 IGMP Snooping..... | 40 |
| 3.2.6 QoS..... | 41 |
| 3.2.7 SNMP | 51 |
| 3.2.8 DHCP Server | 54 |
| 3.2.9 LLDP..... | 56 |
| 3.2.10 485 Configuration | 58 |
| 3.2.11 PoE..... | 59 |
| 4 Maintenance | 63 |
| 4.1 System Reboot | 63 |
| 4.2 Restoring Default Settings..... | 63 |
| 4.3 Managing Configuration | 63 |
| 4.3.1 Exporting Configuration File..... | 63 |
| 4.3.2 Uploading Configuration File..... | 64 |
| 4.4 Software Update..... | 64 |
| 4.5 Mirroring | 65 |
| 4.6 Ping | 66 |
| 4.7 Functions of Network Management System..... | 66 |
| 4.7.1 Enabling Function and Logging in to Platform | 66 |
| 4.7.2 Exporting Network Management Configuration File..... | 67 |

| | |
|--|-----------|
| 4.7.3 Uploading Network Management Configuration File..... | 67 |
| Appendix 1 Cybersecurity Recommendations | 68 |

1 Login

Before login, make sure:

- You already configure the IP address of the switch. The IP address of VLAN 1 is 192.168.1.110 by default.
- The PC with web browser is connected to the network, and the PC can ping the switch successfully.

Step 1 Enter the IP address (192.168.1.110 by default) of the switch in the address bar of the web browser, and then press Enter key.

Figure 1-1 Web login

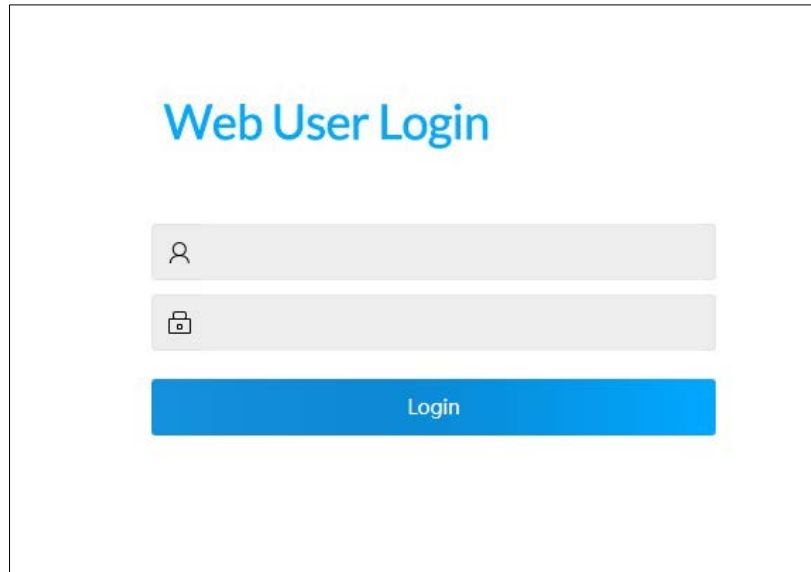
The image shows a web browser interface for logging into a switch. At the top, the text "Web User Login" is displayed in blue. Below this, there are two input fields: the first is for the username, indicated by a person icon, and the second is for the password, indicated by a lock icon. Both fields are currently empty. Below the input fields is a blue button labeled "Login".

Step 2 Enter user name and password. The user name and the password are admin by default.

Step 3 Click **Login**.



Change the password after first login. The password must consist of 8 to 32 non-blank characters and contain at least two types of characters among upper case, lower case, number, and special character (excluding ' " ; : &).

2 Quick Settings

You can view the system information, and set the device parameters, VLAN, link aggregation, IP address and route. Take 4-port PoE switch for example. The quick setting interface is different depending on the models of switch. The actual interface shall prevail.

2.1 System Information

You can view the name, type, serial number, software version, IP address, port status and port information of the device.

After logging in the system, the **Quick Setting** interface is displayed. See Figure 2-1. On the switch, if the port shows green, it means the port is connected successfully. And If the port shows gray, it means the port is not connected or the connection fails.

Figure 2-1 System information

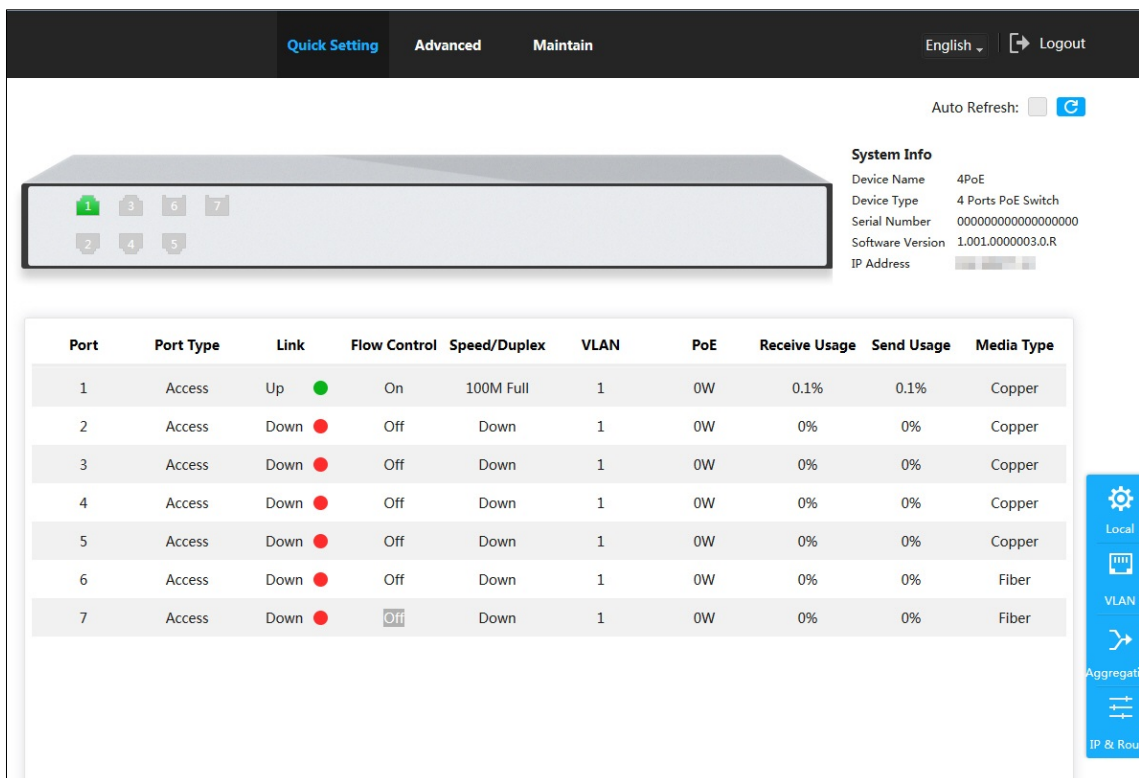



Table 2-1 Port information

| Parameter | Description |
|-----------|--|
| Port | <p>Displays all ports of the switch.</p>  <p>The demonstrated switch contains 7 ports. Port quantity might vary depending on the model you purchased, and the actual product shall prevail.</p> |
| Port Type | Three types: Access , Hybrid , and Trunk . |

| Parameter | Description |
|---------------|--|
| Link | Two link states: Up and Down . Up indicates the port is connected successfully, and Down indicates the port is not connected or the connection fails. |
| Flow Control | Displays the flow control state. |
| Speed/Duplex | <ul style="list-style-type: none"> Online: It displays the port rate and the duplex mode. Offline: It displays Down. |
| VLAN | VLAN port. It is VLAN 1 by default. |
| PoE | Displays the power consumption of POE. Only 1–4 ports are PoE ports.  <ul style="list-style-type: none"> Non-PoE Ethernet switches do not support this function. The number of PoE ports supported by different models is different. |
| Receive Usage | The current receiving speed is divided by the average speed in a certain period (5 minutes usually). |
| Send Usage | The current sending speed is divided by the average speed in a certain period (5 minutes usually). |
| Media Type | Two media types: Copper and Fiber . Copper indicates RJ-45 port, and Fiber indicates fiber port. |

2.2 Local

You can set the system name, IP address, and subnet mask.

Step 1 Click **Local** on the right of **Quick setting** interface.

The **Local** interface is displayed.

Figure 2-2 Local

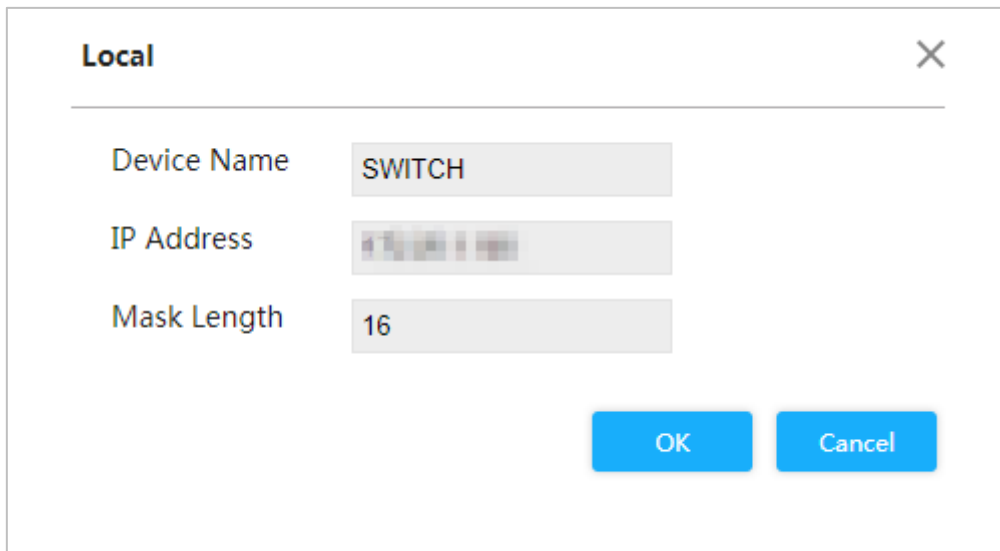

Step 2 Enter the system name, IP address, and mask length.

Step 3 Click **OK**.

2.3 VLAN

Add the port to the VLAN, and configure the VLAN. By default, the port is VLAN1.

Step 1 Click **Vlan** on the **Quick Setting** interface.

The **Vlan** interface is displayed.

Figure 2-3 VLAN

| Port | Mode | Port VLAN | Allowed VLANs |
|------|--------|-----------|---------------|
| 1 | Access | 1 | 1 |
| 2 | Access | 1 | 1 |
| 3 | Access | 1 | 1 |
| 4 | Access | 1 | 1 |
| 5 | Access | 1 | 1 |
| 6 | Access | 1 | 1 |
| 7 | Access | 1 | 1 |

Step 2 Configure the port VLAN parameters.

Table 2-2 Port VLAN configuration parameter

| Parameter | Description |
|---------------|---|
| Port | Displays all ports of the switch. |
| Mode | Three modes: Access , Hybrid , and Trunk . <ul style="list-style-type: none">● Access: When the port connects to terminal devices (such as PC and IPC), select Access.● Trunk: When the port connects to switch, select Trunk.● Hybrid: Not often used. |
| Port VLAN | Add the port to a VLAN. By default, the port belongs to VLAN1, and the range is 1–4094. |
| Allowed VLANs | Set the allowed VLAN. When the mode is Trunk , you can set it. |

Step 3 Click **OK**.

2.4 Aggregation

Add the port to the aggregation. For details, see "3.1.4 Aggregation."

Click **Aggregation** on **Quick Setting** interface, and the **Aggregation** interface is displayed.

Figure 2-4 Aggregation

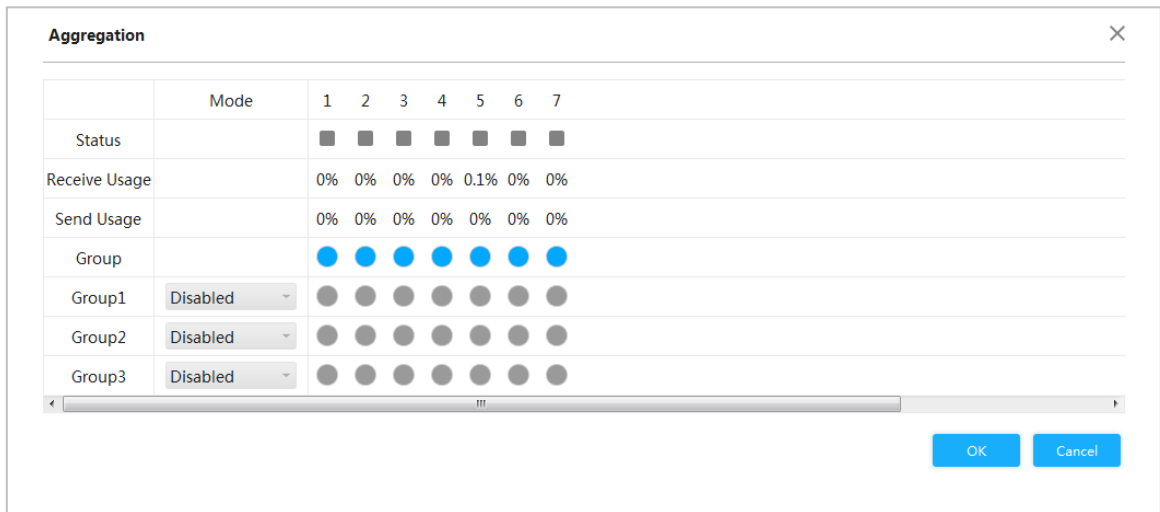

2.4.1 Static Aggregation Configuration

Static aggregation is a method of combining or bundling of multiple switch ports or NICs to form a single etherchannel. For example, add port 1 and port 2 to Static Group 1.

Step 1 Select **Model** as **Static** in group 1, which indicates that the group is static aggregation.

Step 2 Select port 1 and port 2 in group 1 to add the two ports to static aggregation.



For 4-port PoE switch, you can configure up to 3 groups of static aggregation. Static aggregation is different depending on different models of PoE switch. The actual interface shall prevail.

Figure 2-5 Static configuration

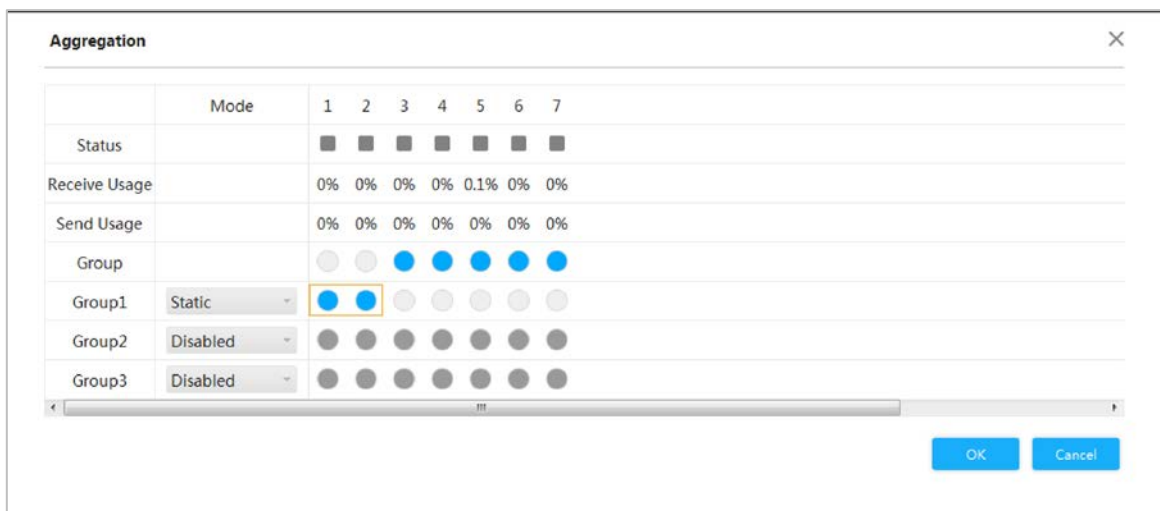

Step 3 Click **OK**.

The port 1 and port 2 form a logical port.

2.4.2 Dynamic Aggregation Configuration

Dynamic aggregation differs from static aggregation in that port quantity is fixed in static aggregation, but quantity of actually aggregated port is adjusted dynamically according to flow rate strategy.

Step 1 Add the ports to the dynamic group.

- 1) Select **LACP (Active)** in the **Mode** area, and add the ports to the aggregation group.
For example, add port 3 and port 4 to aggregation group 2.
- 2) Select **LACP (Passive)** in the **Mode** area, and add the ports to the aggregation group.
For example, add port 5 and port 6 to aggregation group 3.

Figure 2-6 Dynamic configuration

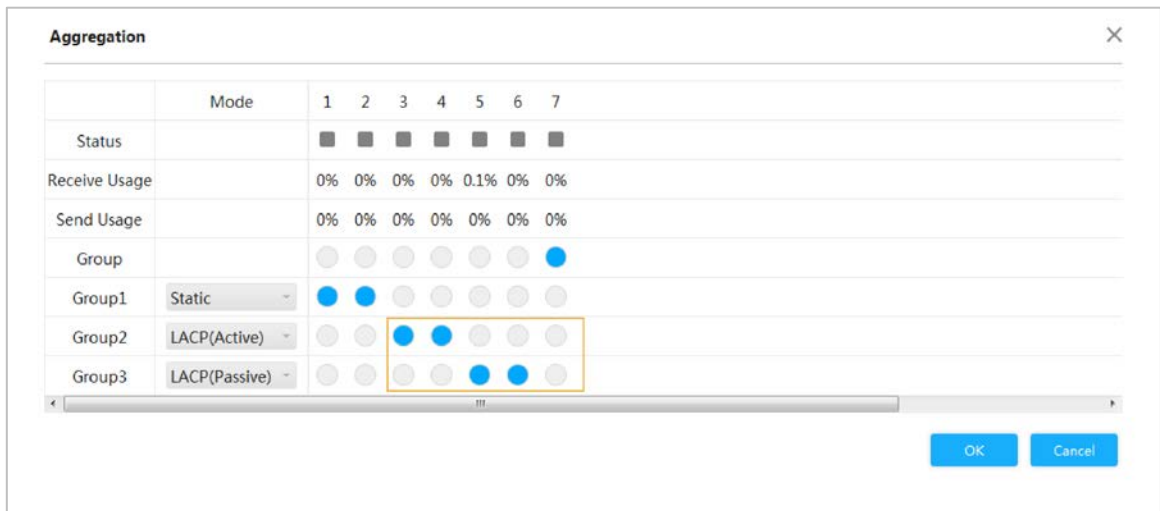

Step 2 Click **OK**.

2.5 IP and Route

You can add the IP address of VLAN virtual interface and IP route. For details, see "3.1.1.2 IP and Route."

Step 1 Click **IP & Route** on the **Quick Setting** interface.

The **IP & Route** interface is displayed.

Figure 2-7 IP and route

Step 2 Add the VLAN interface.

- 1) Click **Add** in the **IP Config** area.

Figure 2-8 VLAN interface

- 2) Configure the parameters.

Table 2-3 VLAN interface

| Parameter | Description |
|-------------|--|
| VLAN | Enter VLAN number. |
| IP address | Set the IP address of the VLAN interface. |
| Mask Length | Set the mask length of the VLAN interface. |

Step 3 Add the IP route.

- 1) Click **Add** in the **Route Config** area.

Figure 2-9 IP route

The screenshot shows a 'Route Config' window with two buttons: '+ Add' and 'Delete'. Below the buttons is a table with the following structure:

| <input type="checkbox"/> | Network | Mask Length | Next Hop | Delete |
|--------------------------|---------|-------------|------------|--------|
| <input type="checkbox"/> | 0.0.0.0 | 0 | 172.12.0.1 | |
| <input type="checkbox"/> | | | | |

2) Configure the parameters.

Table 2-4 IP routes

| Parameter | Description |
|-------------|---|
| Network | It is the destination of the IP packet. |
| Mask Length | Mask length, with the destination address, is to identify the IP address of the destination host or the route. After Logical AND between destination address and network mask, you can get the IP address of the destination host or the route. |
| Next Hop | The next hop IP of the route. |

Step 4 Click **OK**.

3 Advanced Settings

You can configure system, port, VLAN, aggregation, MAC table and other parameters on the advanced settings interface. The advanced settings interface is different depending on the models of switch, and the actual interface shall prevail. Take 4-port PoE switch for example.

3.1 Common Configuration

3.1.1 System Configuration

3.1.1.1 System Information

You can set the device name, IP address, mask length and DHCP enable, and view the software information, hardware information and time.



Be careful when you enable DHCP Client. After enabling DHCP Client, the IP router or DHCP server connecting to the switch will assign IP address to the switch automatically and the existing IP address will be invalidated, and then you cannot access the web interface.

Step 1 Select **Advanced > Common > System Config > System Info**.

The **System Info** interface is displayed.

Figure 3-1 System information

| System Info | IP&Route | Current Time | Log |
|--|--------------------------|--------------|-----|
| System: | | | |
| Device Name: | 4PoE | | |
| IP Address: | [Redacted] | | |
| Mask Length: | 24 | | |
| DHCP Enable: | <input type="checkbox"/> | | |
| Software: | | | |
| Software Version: 1.001.0000003.0.R | | | |
| Compile Date: 2019-07-31 15:04:43+08:00 | | | |
| Hardware: | | | |
| Device Name: 4PoE | | | |
| Device Type: 4 Ports PoE Switch | | | |
| IP Address: | [Redacted] | | |
| Mask Length: | 24 | | |
| MAC Address: 02-00-c1-8b-01-91 | | | |
| Serial Number: 000000000000000000 | | | |
| Time: | | | |
| System Date: 2018-04-09 03:22:52 | | | |
| System Running Time: 0 days 23:21:25 | | | |
| <input type="button" value="Save"/> <input type="button" value="Refresh"/> | | | |

Step 2 Enter the device name, IP address and mask length, and Select **DHCP enable**.

Step 3 Click **Save**.

3.1.1.2 IP and Route

The hosts of different VLANs cannot communicate. Route or the layer 3 switch is needed for forwarding.

The switch supports layer 3 forwarding through VLAN interface. VLAN interface is the virtual interface of layer 3 mode, for layer 3 communication between the VLANs. It is not the physical entity on the device. Every VLAN is related to a VLAN interface, and the VLAN interface can forward packet for the VLAN. Generally, because the VLAN can isolate the broadcasting domain, every VLAN corresponds to a network segment. VLAN interface is the gateway of the network segment, and it supports layer 3 forwarding for the message based on IP address.

Step 1 Select **Advanced > Common > System Config > IP&Route**.

Figure 3-2 IP and route

The screenshot shows the 'IP&Route' configuration page. At the top, there are tabs for 'System Info', 'IP&Route', 'Current Time', and 'Log'. Below the tabs, there are buttons for '+ Add' and 'Delete' under 'IP Setting', and an 'Auto Refresh' checkbox. The 'IP Setting' section contains a table with columns: 'VLAN', 'IP Address', 'Mask Length', 'Delete', and 'Delete IP'. A single entry is shown for VLAN 1 with IP address 192.168.1.1 and Mask Length 16. To the right, there is a table with columns: 'Interface', 'Address', and 'Status'. An entry is shown for Interface 1 with Address 192.168.1.1 and Status UP. Below this, there are buttons for '+ Add' and 'Delete' under 'Route Setting'. The 'Route Setting' section contains a table with columns: 'Network', 'Mask Length', 'Next Hop', and 'Delete'. An entry is shown for Network 0.0.0.0 with Mask Length 0. To the right, there is a table with columns: 'Destination', 'Mask Length', 'Protocol', 'Priority', 'Next Hop', and 'Egress'. Two entries are shown: one for Destination 0.0.0.0 with Mask Length 0, Protocol Static, Priority 60, Next Hop 192.168.1.1, and Egress 0; and another for Destination 192.168.1.0 with Mask Length 16, Protocol Direct, Priority 0, Next Hop VLAN1, and Egress -. At the bottom left, there is a 'Save' button.

Step 2 Add the VLAN interface.

- 1) Click **Add** in **IP Setting** region.

Figure 3-3 Add IP

The screenshot shows the 'Add IP' dialog box. It has a title bar with 'Add IP' and a close button (X). Below the title bar, there are three input fields: 'VLAN', 'IP Address', and 'Mask Length'. At the bottom right, there are two buttons: 'OK' and 'Cancel'.

- 2) Configure the parameters.

Table 3-1 VLAN interface

| Parameter | Description |
|-------------|---|
| VLAN | Enter VLAN number. |
| IP address | Set the IP address of the VLAN interface. |
| Mask Length | Set the mask length of the IP address. |

- 3) Click **OK**.

Step 3 Add the IP route.

- 1) Click **Add** in the **Route Setting** region.

Figure 3-4 Add route

Table 3-2 Description of IP routes

| Parameter | Description |
|-------------|---|
| Network | It is the destination of the IP packet. |
| Mask Length | Mask length, with destination address, is to identify the IP address of the destination host or the route. After Logical AND between destination address and network mask, you can get the IP address of the destination host or the route. |
| Next Hop | The next hop IP of the route. |

- 2) Click **OK**.

Step 4 Click **Save**.

3.1.1.3 System time

Set the system time of switch.

Select **Advanced > Common > System Config > Current Time**.

Figure 3-5 Current time (1)

System Info | IP&Route | **Current Time** | Log

Current Time

2018-12-17

11 : 19 : 26 Sync PC

NTP Enable

Server1

Server2

Save Refresh

You can set the system time through the following three methods:

- Set the time manually
Set the date and time on **Current Time** interface, and then click **Save**.
- Sync time
Click **Sync PC**, and the switch time synchronizes with the local PC time automatically.
- Sync NTP server time
Only with NTP server configured in the network can you enable this function in the following steps:

Step 1 Select the **NTP Enable** box to enable the NTP service.

Step 2 Set the IP address of the NTP server.

Figure 3-6 Current time (2)

System Info | IP&Route | **Current Time** | Log

Current Time

2018-12-17

11 : 20 : 47 Sync PC

NTP Enable

Server1

Server2

Save Refresh

Step 3 Click **Save**.

The switch time automatically synchronizes with the time of server 1.

3.1.1.4 Log

You can view logs, export logs and clear logs.

Select **Advanced > Common > System Config > Log**. The **Log** interface is displayed.

Figure 3-7 Log

The screenshot shows the 'Log' interface with the following components:

- Navigation tabs: System Info, IP&Route, Current Time, Log (selected).
- Start Time: 1970-01-01 00:00:00
- End Time: 2018-05-13 10:17:27
- Log Level: All (dropdown menu)
- Search button: Search
- Table of log entries:

| No. | Log Time | Log Level | Description |
|-----|---------------------|---------------|---|
| 1 | 2018-03-31 03:16:59 | Informational | SYS-BOOTING: Switch just made a cold boot. |
| 2 | 2018-03-31 03:17:04 | Informational | USERS: modify the password of user [admin] |
| 3 | 2018-03-31 03:17:07 | Notice | CHIP 1, PSE CHIP FOUND |
| 4 | 2018-03-31 03:17:08 | Notice | LINK-CHANGED: Interface GigabitEthernet 1/1, changed state to up (MEP). |
| 5 | 2018-03-31 03:17:08 | Notice | LINK-CHANGED: Interface GigabitEthernet 1/2, changed state to up (MEP). |
| 6 | 2018-03-31 03:17:08 | Notice | LINK-CHANGED: Interface GigabitEthernet 1/3, changed state to up (MEP). |
| 7 | 2018-03-31 03:17:08 | Notice | LINK-CHANGED: Interface GigabitEthernet 1/4, changed state to up (MEP). |
| 8 | 2018-03-31 03:17:08 | Notice | LINK-CHANGED: Interface GigabitEthernet 1/5, changed state to up (MEP). |
| 9 | 2018-03-31 03:17:08 | Notice | LINK-CHANGED: Interface GigabitEthernet 1/6, changed state to up (MEP). |

Navigation: << 1 / 52 >> 1 >

Buttons: Export, Clear

- View logs.
Set the start time, end time and log level, and then click **Search** to view the details of the logs. **Log Level** includes **Error**, **Warning**, **Notice** and **Information**.
- Click **Export** to export all logs.
- Click **Clear** to clear all logs.

3.1.2 Port Configuration

You can set the port parameters, including speed, full duplex and half duplex, and so on.

Step 1 Select **Advanced > Common > Port**.



Figure 3-8 Port configuration

| Port | Link | Speed Duplex Status | Speed Duplex Setting | Flow Control Status | Flow Control Setting | Ingress Limit Enable | Ingress Limit (kbps) | Egress Limit Enable | Egress Limit (kbps) | Receive Usage | Send Usage |
|------|------|---------------------|----------------------|---------------------|----------------------|----------------------|----------------------|---------------------|---------------------|---------------|------------|
| 1 | Down | Down | Auto | Off | | | 500 | | 500 | 0% | 0% |
| 2 | Down | Down | Auto | Off | | | 500 | | 500 | 0% | 0% |
| 3 | Down | Down | Auto | Off | | | 500 | | 500 | 0% | 0% |
| 4 | Down | Down | Auto | Off | | | 500 | | 500 | 0% | 0% |
| 5 | Up | 1G Full | Auto | Off | | | 500 | | 500 | 0.1% | 0% |
| 6 | Down | Down | Auto | Off | | | 500 | | 500 | 0% | 0% |
| 7 | Down | Down | Auto | Off | | | 500 | | 500 | 0% | 0% |

Save Refresh

Table 3-3 Port parameter

| Parameter | Description |
|----------------------|--|
| Port | Displays all ports of the switch. |
| Link | Green Up indicates the port is connected successfully, and Red Down indicates the port is not connected or the connection fails. |
| Speed Duplex Status | Down means disconnection, and the specific speed means successful connection. Full means full duplex; Half means half duplex. |
| Speed Duplex Setting | Set the speed and the duplex mode. The speed and duplex mode of combo port is fixed to Auto . |
| Flow Control State | Displays flow control actual negotiator or enable status, including ON and OFF. <ul style="list-style-type: none"> ● ON: Negotiation succeeds. ● OFF: Negotiation fails. |
| Flow Control Setting | ON/OFF flow control function. <ul style="list-style-type: none"> ● : Flow control is ON. ● : Flow control is OFF. |
| Ingress Limit Enable | Enable/Disable ingress limit. <ul style="list-style-type: none"> ● : Ingress enable is enabled. ● : Ingress enable is disabled. |
| Ingress Limit (kbps) | Set the ingress limit. |

| Parameter | Description |
|---------------------|--|
| Egress Limit Enable | Enable/Disable egress limit. <ul style="list-style-type: none">  : Egress enable is enabled.  : Egress enable is disabled. |
| Egress Limit (kbps) | Set the egress limit. |
| Receive Usage | Displays the acceptance usage. |
| Send Usage | Displays the send usage. |

Step 2 Click **Save**.

3.1.3 VLAN Configuration

Add the port to the VLAN, and configure the VLAN. By default, the port belongs to VLAN1.

Step 1 Select **Advanced > Common > VLAN Settings**.

The **VLAN Settings** interface is displayed.

Figure 3-9 VLAN settings

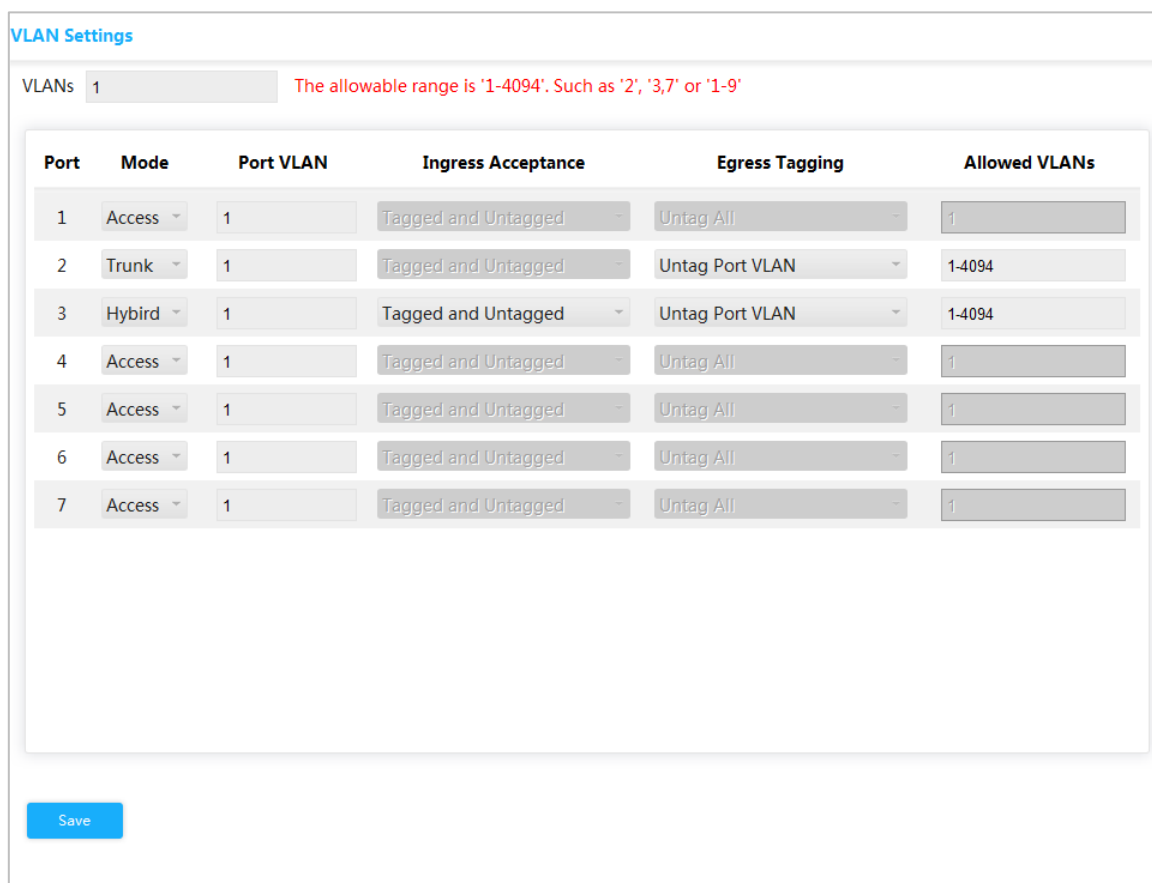

VLANs 1 The allowable range is '1-4094'. Such as '2', '3,7' or '1-9'

| Port | Mode | Port VLAN | Ingress Acceptance | Egress Tagging | Allowed VLANs |
|------|--------|-----------|---------------------|-----------------|---------------|
| 1 | Access | 1 | Tagged and Untagged | Untag All | 1 |
| 2 | Trunk | 1 | Tagged and Untagged | Untag Port VLAN | 1-4094 |
| 3 | Hybird | 1 | Tagged and Untagged | Untag Port VLAN | 1-4094 |
| 4 | Access | 1 | Tagged and Untagged | Untag All | 1 |
| 5 | Access | 1 | Tagged and Untagged | Untag All | 1 |
| 6 | Access | 1 | Tagged and Untagged | Untag All | 1 |
| 7 | Access | 1 | Tagged and Untagged | Untag All | 1 |

Save

Step 2 Enter 1, 2 in VLANs to create VLAN 1 and VLAN 2.

Step 3 Configure the port VLAN parameters.

Table 3-4 Port VLAN configuration parameter

| Parameter | Description |
|-----------|---|
| Port | Displays all ports of the switch. |
| Mode | Three modes: Access , Hybrid , and Trunk . |
| Port VLAN | Add the port to a VLAN. By default, the port belongs to VLAN1. The range is 1–4094. |

| Parameter | Description |
|--------------------|--|
| Ingress Acceptance | Displays whether data can flow into the port. Only Hybrid supports the configuration (By default, all data flows into the port under other models). See the following situations: <ul style="list-style-type: none"> ● Tagged and Untagged: All data flows into the port. ● Tagged only: Only tagged data can flow into the port. ● Untagged only: Only untagged data can flow into the port. |
| Egress Tagging | Displays whether to tag the data that will egress the port. See the following three situations: <ul style="list-style-type: none"> ● Untag Port VLAN: If the data flow tag is the same with PVID, the tag will be peeled. ● Tag All: All data will be tagged. ● Untag All: All data will not be tagged. |
| Allowed VLANs | Set the allowed VLAN. |

Step 4 Click **Save**.

3.1.4 Aggregation

Aggregation is to form the multiple physical ports of the switch into the logical port. The multiple links in the same group can be regarded as a logical link with the larger bandwidth.

Through aggregation, the ports in the same group can share the communication flow, to make a larger bandwidth. Besides, the ports in the same group can back up reciprocally and dynamically to enhance the link reliability.

3.1.4.1 Static Configuration

Step 1 Select **Advanced > Common > Aggregation**.

Figure 3-10 Aggregation interface

| Aggregation | | | | | | | | |
|---|----------|----|----|----|----|------|----|----|
| Aggregation Configuration <input checked="" type="checkbox"/> Source MAC Address <input type="checkbox"/> Destination MAC Address <input checked="" type="checkbox"/> IP Address <input checked="" type="checkbox"/> TCP/UDP Port | | | | | | | | |
| | Mode | 1 | 2 | 3 | 4 | 5 | 6 | 7 |
| Status | | ■ | ■ | ■ | ■ | ■ | ■ | ■ |
| Receive Usage | | 0% | 0% | 0% | 0% | 0.1% | 0% | 0% |
| Send Usage | | 0% | 0% | 0% | 0% | 0% | 0% | 0% |
| Group | | ● | ● | ● | ● | ● | ● | ● |
| Group1 | Disabled | ● | ● | ● | ● | ● | ● | ● |
| Group2 | Disabled | ● | ● | ● | ● | ● | ● | ● |
| Group3 | Disabled | ● | ● | ● | ● | ● | ● | ● |

Step 2 Select the aggregation load balancing algorithm mode in **Aggregation Configuration**. There are four types:

- **Source MAC Address**: The aggregation load balancing algorithm based on MAC address.

- Destination MAC Address: The aggregation load balancing algorithm based on destination MAC address.
- IP Address: The aggregation load balancing algorithm based on source IPv4 address and destination IPv4 address.
- TCP/UDP Port: The aggregation load balancing algorithm based on source and destination TCP/UDP port.

Step 3 Select **Static** in the **Mode** area, and add the ports to the dynamic aggregation group. For example, add port 1 and port 2 to aggregation group.



Regarding 4-port PoE switch, at most 3 static aggregation groups can be set at the same time. The static aggregation group is different depending on the models of switch. The actual interface shall prevail.

Figure 3-11 Static configuration

| Aggregation Configuration | | <input checked="" type="checkbox"/> Source MAC Address <input type="checkbox"/> Destination MAC Address <input checked="" type="checkbox"/> IP Address <input checked="" type="checkbox"/> TCP/UDP Port | | | | | | |
|---------------------------|----------|---|----|----|----|------|----|----|
| | Mode | 1 | 2 | 3 | 4 | 5 | 6 | 7 |
| Status | | ■ | ■ | ■ | ■ | ■ | ■ | ■ |
| Receive Usage | | 0% | 0% | 0% | 0% | 0.1% | 0% | 0% |
| Send Usage | | 0% | 0% | 0% | 0% | 0% | 0% | 0% |
| Group | | ○ | ○ | ● | ● | ● | ● | ● |
| Group1 | Static | ● | ● | ○ | ○ | ○ | ○ | ○ |
| Group2 | Disabled | ○ | ○ | ○ | ○ | ○ | ○ | ○ |
| Group3 | Disabled | ○ | ○ | ○ | ○ | ○ | ○ | ○ |

Step 4 Click **Save**.

The port 1 and port 2 form a logical port.

3.1.4.2 LACP

LACP (Link Aggregation Control Protocol) is the protocol for link dynamic aggregation. LACP communicates with another port through LACPDU (Link Aggregation Control Protocol Data Unit).

Select the port role from the drop-down list in **Mode**. There are two types:

- **Active:** The port can send LACPDU packet actively to the opposite port, and analyzes the LACP.
- **Passive:** The port cannot send LACPDU packet actively. After receiving the LACP packet sent by the opposite port, the port analyzes the LACP.

Step 1 Select **Advanced > Common > Aggregation**.

Figure 3-12 LACP (1)

| Aggregation | | | | | | | | |
|---|----------|----|----|----|----|------|----|----|
| Aggregation Configuration <input checked="" type="checkbox"/> Source MAC Address <input type="checkbox"/> Destination MAC Address <input checked="" type="checkbox"/> IP Address <input checked="" type="checkbox"/> TCP/UDP Port | | | | | | | | |
| | Mode | 1 | 2 | 3 | 4 | 5 | 6 | 7 |
| Status | | ■ | ■ | ■ | ■ | ■ | ■ | ■ |
| Receive Usage | | 0% | 0% | 0% | 0% | 0.1% | 0% | 0% |
| Send Usage | | 0% | 0% | 0% | 0% | 0% | 0% | 0% |
| Group | | ● | ● | ● | ● | ● | ● | ● |
| Group1 | Disabled | ● | ● | ● | ● | ● | ● | ● |
| Group2 | Disabled | ● | ● | ● | ● | ● | ● | ● |
| Group3 | Disabled | ● | ● | ● | ● | ● | ● | ● |

Save Refresh

Step 2 Select **LACP (Passive)** in the **Mode** area, and add the port member to the dynamic aggregation group. For example, add port 3 and port 4 to aggregation Group 2.

Step 3 Select **LACP (Passive)** in the **Mode** area, and add the port member to the dynamic aggregation group. For example, add port 5 and port 6 to aggregation Group 3.

Figure 3-13 LACP (2)

| Aggregation | | | | | | | | |
|---|---------------|----|----|----|----|------|----|----|
| Aggregation Configuration <input checked="" type="checkbox"/> Source MAC Address <input type="checkbox"/> Destination MAC Address <input checked="" type="checkbox"/> IP Address <input checked="" type="checkbox"/> TCP/UDP Port | | | | | | | | |
| | Mode | 1 | 2 | 3 | 4 | 5 | 6 | 7 |
| Status | | ■ | ■ | ■ | ■ | ■ | ■ | ■ |
| Receive Usage | | 0% | 0% | 0% | 0% | 0.1% | 0% | 0% |
| Send Usage | | 0% | 0% | 0% | 0% | 0% | 0% | 0% |
| Group | | ● | ● | ● | ● | ● | ● | ● |
| Group1 | Disabled | ● | ● | ● | ● | ● | ● | ● |
| Group2 | LACP(Active) | ● | ● | ● | ● | ● | ● | ● |
| Group3 | LACP(Passive) | ● | ● | ● | ● | ● | ● | ● |

Save Refresh

Step 4 Click **Save**.

3.1.5 MAC Table

MAC (Media Access Control) Table records the relationship between the MAC address and the port, and the information including the VLAN that the port belongs to. When the device is forwarding the packet, it queries in the MAC address table for the destination MAC address of the packet. If the destination MAC address of the packet is contained in the MAC address table, the packet is forwarded through the port in the table directly. And if the destination MAC address of the packet is not contained in the MAC address table, the device adopts broadcasting to forward the packet to all the ports except the receiving port in VLAN.

3.1.5.1 Adding Static MAC Table

Step 1 Select **Advanced > Common > MAC Table > MAC Address Table**.

Figure 3-14 MAC address table

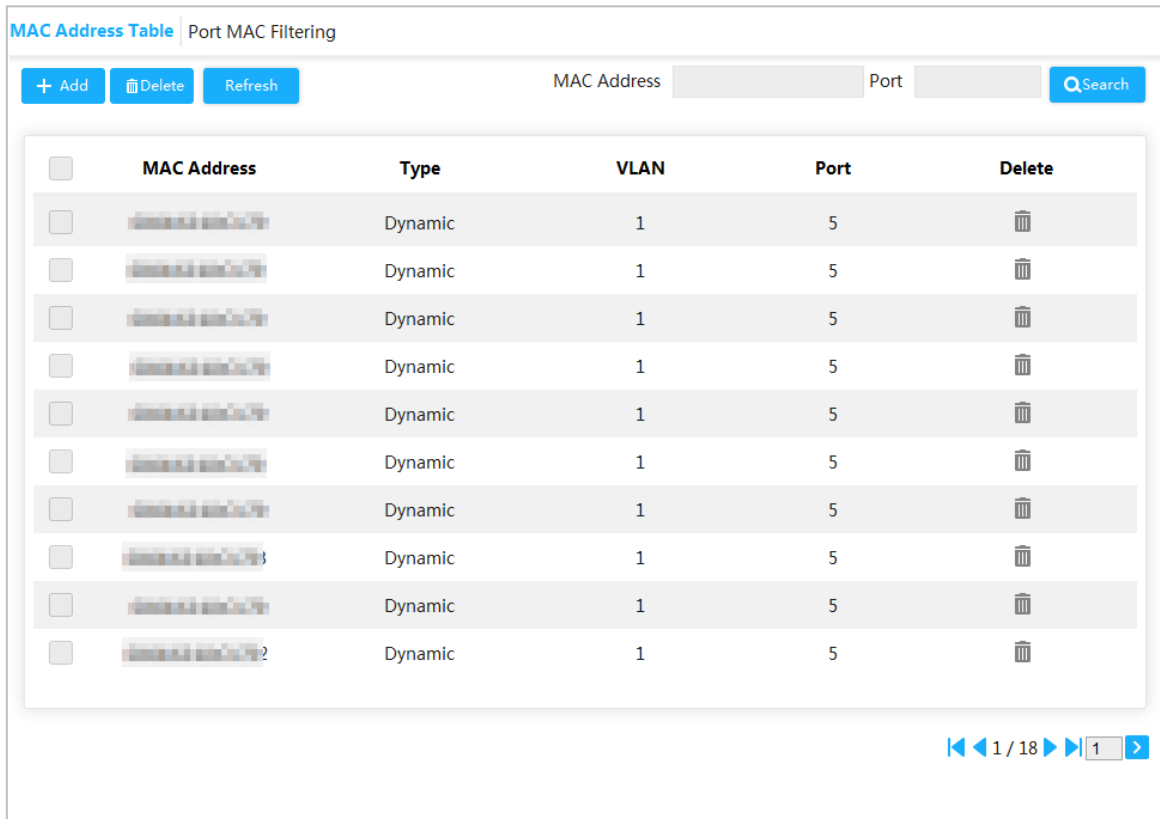

Step 2 Bind the MAC address to the port in the certain VLAN. For example, bind the MAC address 00:00:00:00:00:01 to the port 3 in VLAN 2.

- 1) Click **Add**.
The **Add Static MAC Address** interface is displayed.
- 2) Set the MAC address, port and VLAN.

Figure 3-15 Adding static MAC table

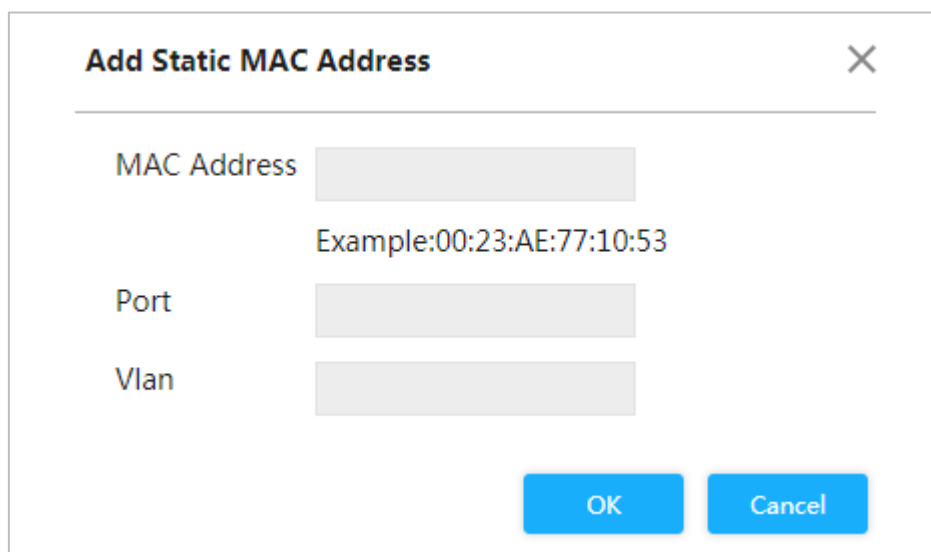

- 3) Click **OK**.

3.1.5.2 Port MAC Filtering

After enabling port MAC filtering, the following two MAC devices can communicate with the port.

- Devices in MAC allowlist
- The static MAC devices changing from the dynamic MAC devices

Step 1 Select **Advanced > Common > MAC Table > Port MAC Filtering**.

The **Port MAC Filtering** interface is displayed.

Figure 3-16 Port MAC filtering

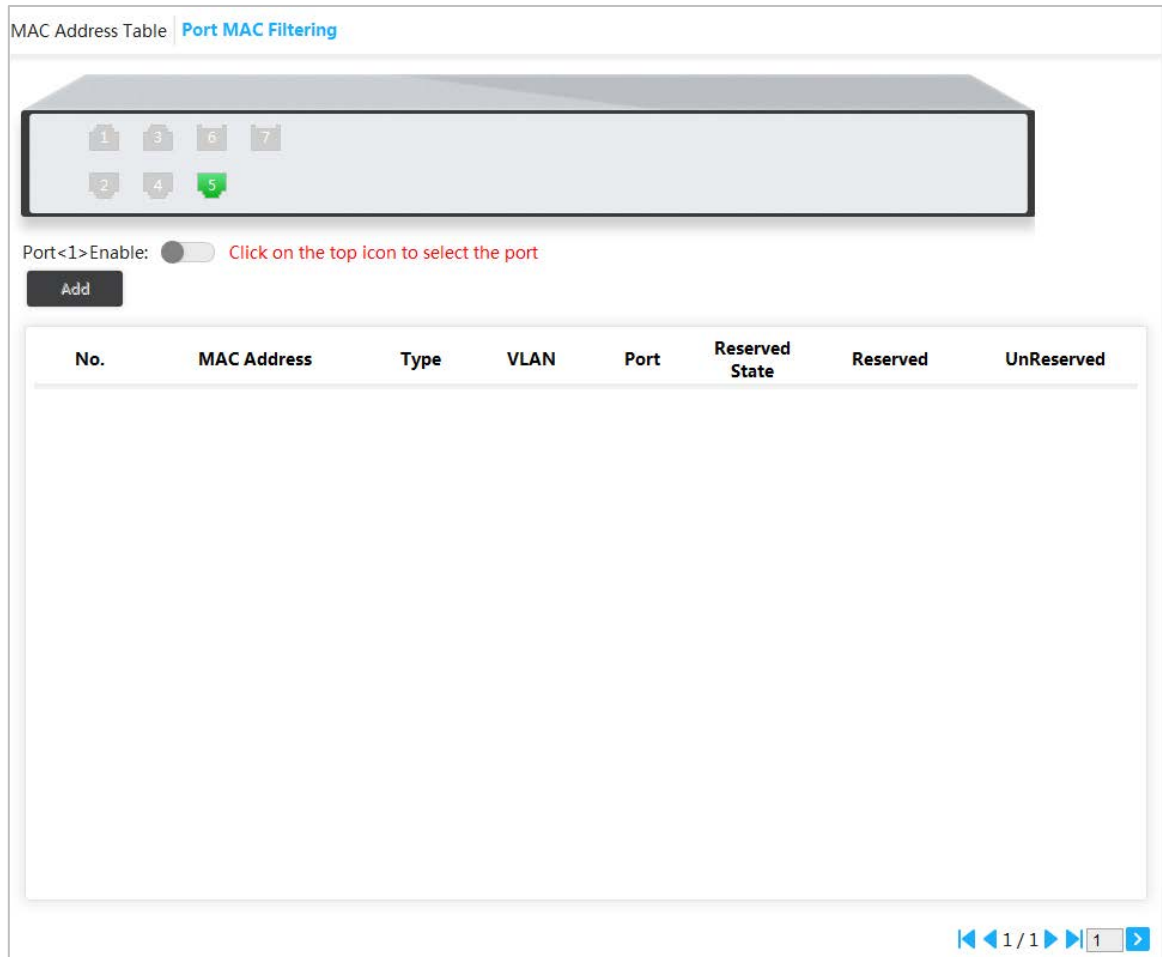

Step 2 Select the port, such as port 5.

Step 3 Click behind **Port <5> Enable** to enable the port.

Figure 3-17 Enable port MAC filtering

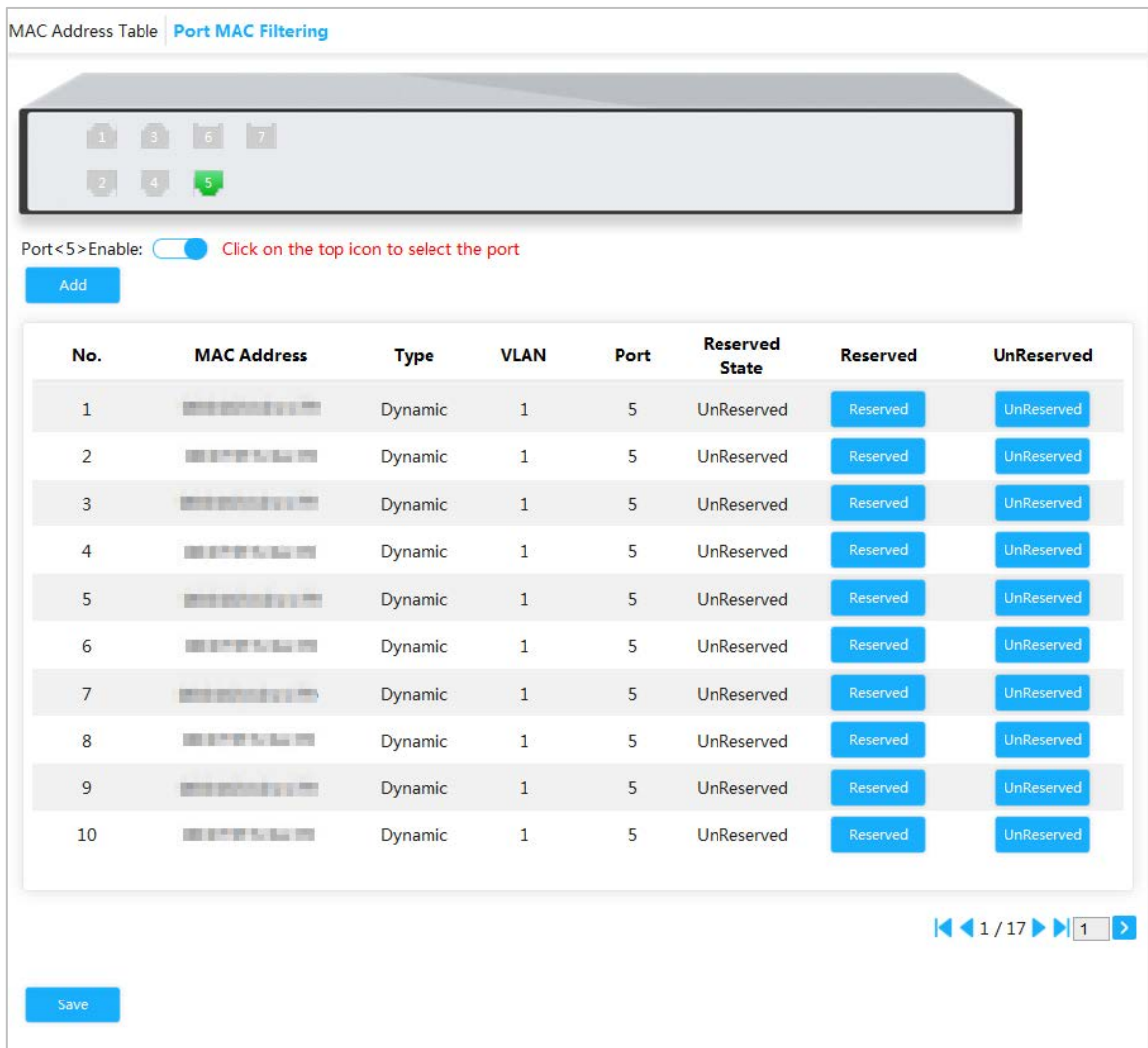

- Change dynamic MAC device to static.
 - 1) Select one record, and click **Reserved**.
 - 2) Click **Save**. The type changes from **Dynamic** to **Static**.
Static MAC devices can communicate with the port normally.
- Add MAC allowlist.
 - 1) Click **Add**.

Figure 3-18 Add MAC allowlist

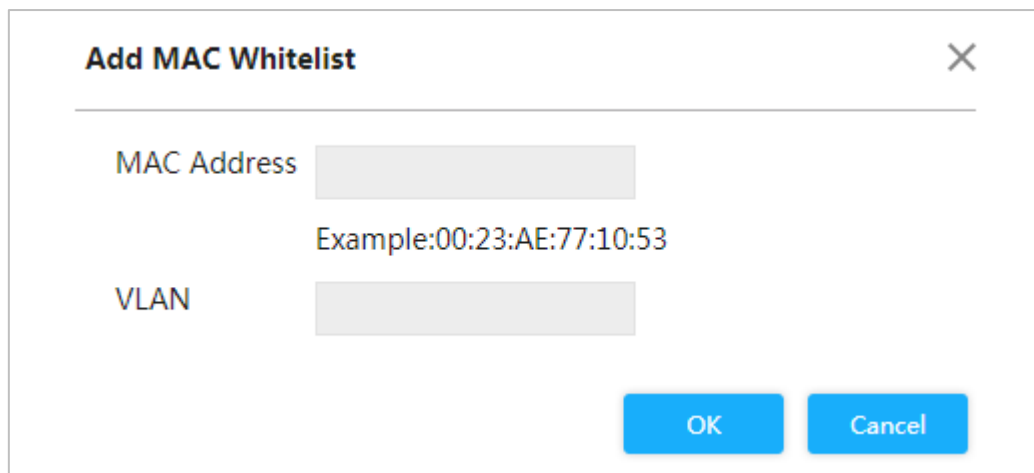

- 2) Set MAC address and VLAN.

3) Click **OK**.

The devices in MAC allowlist can communicate with port normally.

3.1.6 Spanning Tree

The spanning tree protocol is the protocol of layer 2. It can eliminate the ring cycle of layer 2 by choosing to block the redundant links in the network, and it can back up the links.

Similar to other protocols, the spanning tree protocol is updated with the development of the network: From STP (Spanning Tree Protocol), to RSTP (Rapid Spanning Tree Protocol), and to the latest MSTP (Multiple Spanning Tree Protocol).

Step 1 Select **Advanced > Common > Spanning Tree > STP Ports Settings**.

Figure 3-19 STP ports settings

| Port | <input type="checkbox"/> Enable Priority | RPC | State | Status | Designated Bridge | Designated Port |
|------|--|-----|-------|--------|-------------------|-----------------|
|------|--|-----|-------|--------|-------------------|-----------------|

Step 2 Select the STP mode: **STP**, **RSTP** and **MSTP**.

- **STP**: The most basic spanning tree protocol.
- **RSTP**: Improved based on STP, and realizes rapid convergence of network topology.
- **MSTP**: Remedies the defects of STP and RSTP. MSTP not only realizes rapid convergence, but also provides better load sharing mechanism for the redundant links by forwarding the flow from different VLANs through their own paths.

Step 3 Click **Save**, and the results are various according to the different modes.

Figure 3-20 STP

STP Port Settings

STP Mode: STP

| Port | <input type="checkbox"/> Enable Priority | RPC | State | Status | Designated Bridge | Designated Port |
|------|--|-----|-------|---------|-------------------|-----------------|
| 1 | <input type="checkbox"/> | 128 | - | Non-STP | Discarding | - |
| 2 | <input type="checkbox"/> | 128 | - | Non-STP | Discarding | - |
| 3 | <input type="checkbox"/> | 128 | - | Non-STP | Discarding | - |
| 4 | <input type="checkbox"/> | 128 | - | Non-STP | Discarding | - |
| 5 | <input type="checkbox"/> | 128 | - | Non-STP | Forwarding | - |
| 6 | <input type="checkbox"/> | 128 | - | Non-STP | Discarding | - |
| 7 | <input type="checkbox"/> | 128 | - | Non-STP | Discarding | - |

Save

Figure 3-21 RSTP

STP Mode: RSTP

| Port | <input type="checkbox"/> Enable Priority | RPC | State | Status | Designated Bridge | Designated Port |
|------|--|-----|-------|---------|-------------------|-----------------|
| 1 | <input type="checkbox"/> | 128 | - | Non-STP | Discarding | - |
| 2 | <input type="checkbox"/> | 128 | - | Non-STP | Discarding | - |
| 3 | <input type="checkbox"/> | 128 | - | Non-STP | Discarding | - |
| 4 | <input type="checkbox"/> | 128 | - | Non-STP | Discarding | - |
| 5 | <input type="checkbox"/> | 128 | - | Non-STP | Forwarding | - |
| 6 | <input type="checkbox"/> | 128 | - | Non-STP | Discarding | - |
| 7 | <input type="checkbox"/> | 128 | - | Non-STP | Discarding | - |

Save

Figure 3-22 MSTP

STP Port Settings

STP Mode: MSTP

| Port | <input type="checkbox"/> Enable Priority | RPC | State | Status | Designated Bridge | Designated Port |
|------|--|-----|-------|---------|-------------------|-----------------|
| 1 | <input type="checkbox"/> | 128 | - | Non-STP | Discarding | - |
| 2 | <input type="checkbox"/> | 128 | - | Non-STP | Discarding | - |
| 3 | <input type="checkbox"/> | 128 | - | Non-STP | Discarding | - |
| 4 | <input type="checkbox"/> | 128 | - | Non-STP | Discarding | - |
| 5 | <input type="checkbox"/> | 128 | - | Non-STP | Forwarding | - |
| 6 | <input type="checkbox"/> | 128 | - | Non-STP | Discarding | - |
| 7 | <input type="checkbox"/> | 128 | - | Non-STP | Discarding | - |

Save

Step 4 Select 3 ports at least to combine an STP/RSTP/MSTP snoop. For example: Port 1, port 2 and port 3 combine an STP snoop.

Figure 3-23 STP snoop

STP Port Settings

STP Mode: STP

| Port | <input type="checkbox"/> Enable Priority | RPC | State | Status | Designated Bridge | Designated Port |
|------|--|-----|-------|---------|-------------------|-----------------|
| 1 | <input checked="" type="checkbox"/> | 128 | - | Non-STP | Discarding | - |
| 2 | <input checked="" type="checkbox"/> | 128 | - | Non-STP | Discarding | - |
| 3 | <input checked="" type="checkbox"/> | 128 | - | Non-STP | Discarding | - |
| 4 | <input type="checkbox"/> | 128 | - | Non-STP | Discarding | - |
| 5 | <input type="checkbox"/> | 128 | - | Non-STP | Forwarding | - |
| 6 | <input type="checkbox"/> | 128 | - | Non-STP | Discarding | - |
| 7 | <input type="checkbox"/> | 128 | - | Non-STP | Discarding | - |

Save

Step 5 Click **Save**.

The states of port 1, port 2 and port 3 will change.

3.1.7 Long Distance PoE

After you enable long distance PoE, the maximum transmission distance will change from 100 m to 250 m, and the transmission speed will be reduced from 1 Gbps to 10 Mbps.



Non-PoE Ethernet switches do not support this function.

Select **Advanced > System Config > Long Distance PoE**, and then select the check box of the corresponding port to enable long distance PoE. **Click Save.**

Figure 3-24 Long distance PoE

| Port | Enable |
|------|--------------------------|
| 1 | <input type="checkbox"/> |
| 2 | <input type="checkbox"/> |
| 3 | <input type="checkbox"/> |
| 4 | <input type="checkbox"/> |
| 5 | <input type="checkbox"/> |
| 6 | <input type="checkbox"/> |
| 7 | <input type="checkbox"/> |
| 8 | <input type="checkbox"/> |

Save

3.2 Seldom-used Configurations

3.2.1 ERPS

ERPS (Ethernet Ring Protection Switching) is the loop prevention protocol standard of layer 2 defined by ITU-T, and the standard number is ITU-T G.8032/Y1344. So it is also called G.8032. It defines RAPS (Ring Auto Protection Switching) protocol packet and protection switching scheme.

ERPS supports two versions (V1 and V2). V1 was released by ITU-T in June 2008, and V2 was released by ITU-T in August 2010. V2 is compatible with V1, and adds the following functions:

- Multi-ring networks including crossing ring.
- Sub-ring switch RAPS packet by virtual channel or non-virtual channel.
- Forcedly and manually switch blocks.
- ERPS reverse switch is configurable.



Only some models of switches support ERPS.

3.2.1.1 MEP Configuration

MEP (Maintenance Entity Point) is a part of ERPS.

The layer 2 device added into ERPS are called node. Add no more than 2 ports into an ERPS for each node.

Step 1 Select **Advanced > Seldom-used > ERPS > MEP Setting**.

Figure 3-25 MEP configuration

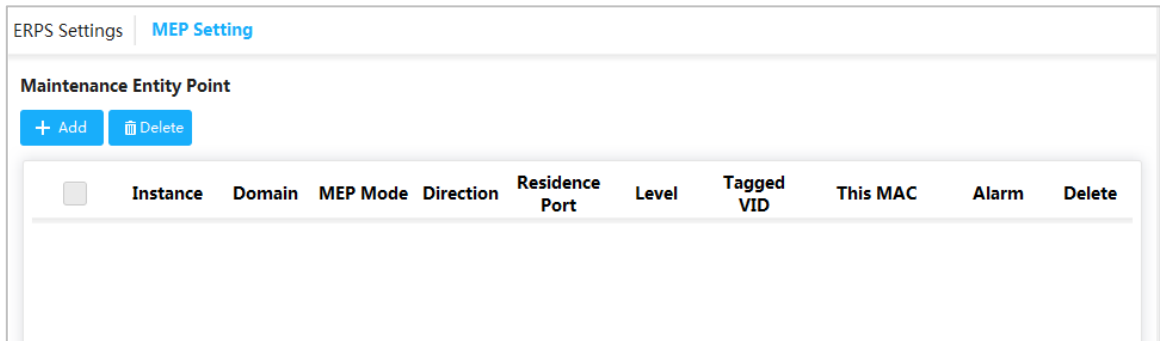

Step 2 Click **Add**.

Figure 3-26 Add

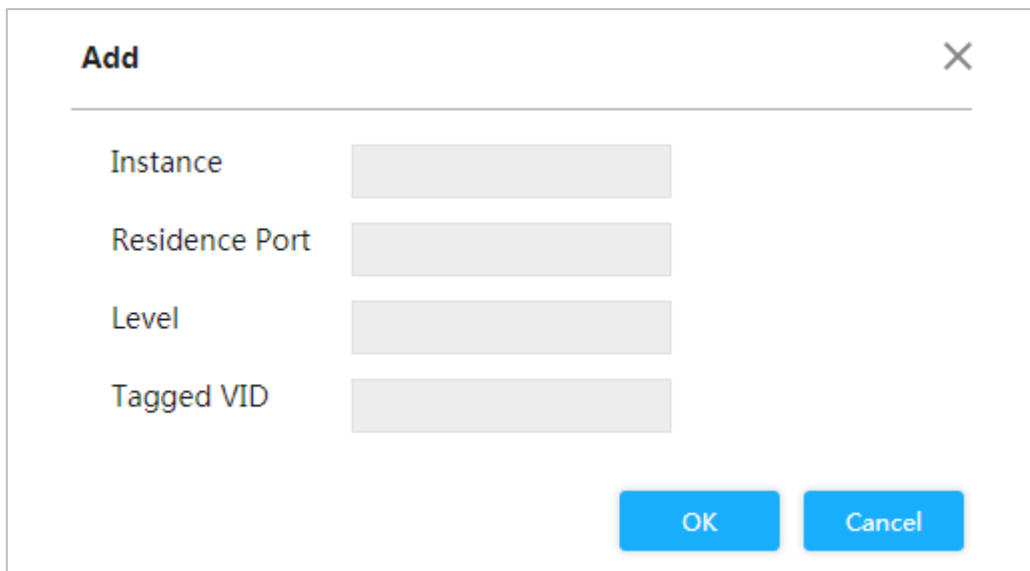

Step 3 Configure the parameters.

Table 3-5 MEP parameters

| Parameter | Description |
|----------------|--|
| Instance | Enter MEP instance number, such as 1. |
| Residence Port | Enter the port number that MEP belongs to, such as Port 1. |
| Level | Maintenance level. It is recommended to set it to be 0. |
| Tagged VID | Enter protocol VLAN, such as VLAN 3. |

Step 4 Click **OK**.

3.2.1.2 ERPS Configuration

Step 1 Select **Advanced > Seldom-used > ERPS > ERPS Settings**.

Figure 3-27 ERPS configuration

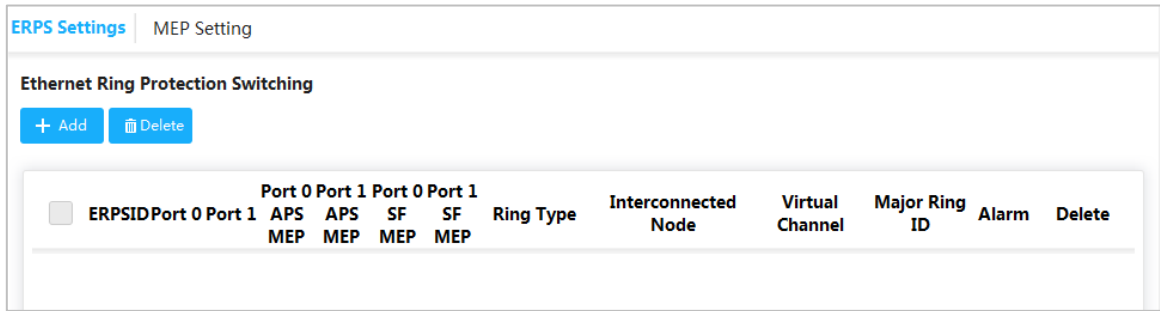

Step 2 Click **Add**.

Figure 3-28 Add ERPS

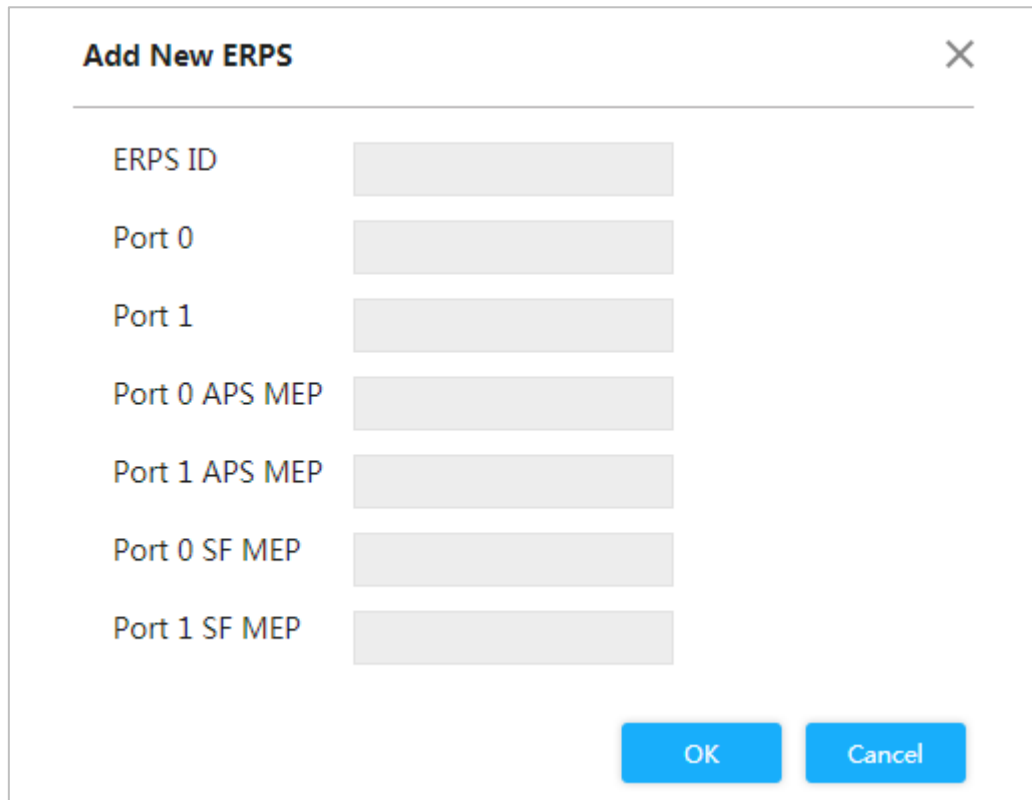

Step 3 Configure the parameters.

Table 3-6 ERPS parameters

| Parameter | Description |
|----------------|--|
| ERPS ID | The ID number of ERPS. |
| Port 0 | The two ports added into the ERPS. |
| Port 1 | |
| Port 0 APS MEP | The corresponding protocol packet ERPS to ERPS port. Keep Port 0 APS MEP consistent with Port 0 SF MEP. Keep Port 1 APS MEP consistent with Port 1 SF MEP. For example: Port 0 APS MEP is 1 and Port 1 APS MEP is 2. |
| Port 1 APS MEP | |
| Port 0 SF MEP | The corresponding aggregation inspection MEP of ERPS port. Keep Port 0 APS MEP consistent with Port 0 SF MEP. Keep Port 1 APS MEP consistent with Port 1 SF MEP. For example: Port 0 SF MEP is 1 and Port 1 SF MEP is 2. |
| Port 1 SF MEP | |

Step 4 Click **OK**.

3.2.1.3 Example: ERPS Single Ring Configuration

Networking Requirement

Three switches, port 1 and port 2 are requested to combine an ERPS. See Figure 3-29. The corresponding relationship: Switch 1: MEP 1 and MEP 2; Switch 2: MEP3 and MEP 4; Switch 3: MEP 5 and MEP 6.

Figure 3-29 ERPS single ring configuration

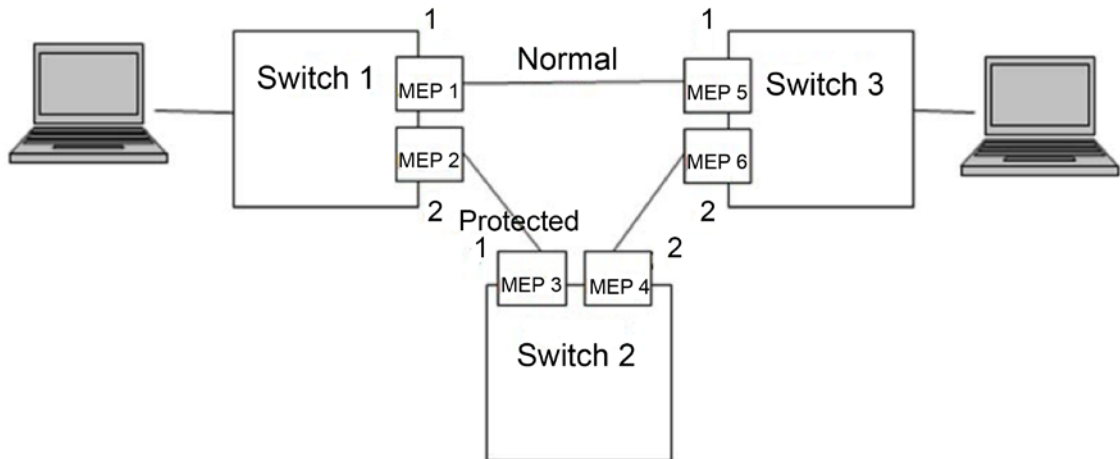

Configuration

Configure the ERPS with the following thoughts:

- 1) Confirm Topology, and plan protection VLAN and protocol VLAN.
- 2) Confirm RPL owner port.
- 3) Ensure to disable the mutex function of the ports.
- 4) VLAN Configuration
- 5) Create MEP.
- 6) Create ERPS, and configure control VLAN and protection instance.
- 7) View the status.

Example

Plan protection VLAN and protocol VLAN to be 2 and 3. Set port 2 of switch 1 to be RPL owner port. Ensure to disable the mutex function of the ports, including STP function and LLDP function.

The configurations of the switch are as following:

Step 1 Configure protection VLAN and protocol VLAN are 2 and 3 separately.

- 1) Select **Advanced > Common > VLAN Settings**.
- 2) Set the mode of port 1 and port 2 to be **Trunk**. See Figure 3-30.
- 3) Set the port VLAN of port 1 and port 2 to be 1.
- 4) Set the allowed VLAN to be 2 and 3.
- 5) Click **Save**.

Figure 3-30 Add port 1 and port 2 into VLAN 1

VLAN Settings

VLANs The allowable range is '1-4094'. Such as '2', '3,7' or '1-9'

| Port | Mode | Port VLAN | Ingress Acceptance | Egress Tagging | Allowed VLANs |
|------|--------|-----------|---------------------|----------------|---------------|
| 1 | Access | 1 | Tagged and Untagged | Untag All | 1 |
| 2 | Access | 2 | Tagged and Untagged | Untag All | 2 |
| 3 | Access | 3 | Tagged and Untagged | Untag All | 3 |
| 4 | Access | 4 | Tagged and Untagged | Untag All | 4 |
| 5 | Access | 5 | Tagged and Untagged | Untag All | 5 |
| 6 | Access | 1 | Tagged and Untagged | Untag All | 1 |
| 7 | Access | 1 | Tagged and Untagged | Untag All | 1 |

Step 2 Create MEP1 and MEP 2

- 1) Select **Advanced > Seldom-used > ERPS > MEP Setting**.
- 2) Click **Add**.
- 3) Set Instance to be 1. See Figure 3-31.
- 4) Set Residence Port to be 1.
- 5) Set Level to be 0.
- 6) Set Tagged VID to be 3, that is protocol VLAN.
- 7) Click **OK**.

Figure 3-31 Add MEP

Add ✕

Instance

Residence Port

Level

Tagged VID

Add MEP2 in the same way. Set Instance to be 2, Residence port to be 2, Level to be 0 and Tagged VID to be 3.

Step 3 Click **1** and **2** separately under **Instance** to enter the configuration interface. Modify MEP ID and add peer ID.

Figure 3-32 Configure the peer ID of MEP 1

MEP Configuration

Instance Data

| Instance | Domain | MEP Mode | Direction | Residence Port | This MAC | Oper State |
|----------|--------|----------|-----------|----------------|-------------------|------------------------------------|
| 1 | Port | MEP | ingress | 1 | 90-02-A9-DA-67-CD | ■ |

Instance Configuration

| Level | MEP ID | Tagged VID |
|-------|--------|------------|
| 0 | 1 | 3 |

Peer MEP Configuration Add

| Peer MEP ConfigId | Unicast Peer MAC | Delete |
|-------------------|-------------------|--|
| 5 | 00:00:00:00:00:00 | Delete |

OK Cancel

Figure 3-33 Configure the peer ID of MEP 2

MEP Configuration

Instance Data

| Instance | Domain | MEP Mode | Direction | Residence Port | This MAC | Oper State |
|----------|--------|----------|-----------|----------------|-------------------|------------------------------------|
| 2 | Port | MEP | ingress | 2 | 90-02-A9-DA-67-CE | ■ |

Instance Configuration

| Level | MEP ID | Tagged VID |
|-------|--------|------------|
| 0 | 1 | 3 |

Peer MEP Configuration Add

| Peer MEP ConfigId | Unicast Peer MAC | Delete |
|-------------------|-------------------|--|
| 3 | 00:00:00:00:00:00 | Delete |

OK Cancel

Step 4 Click **OK**.

Step 5 Create ERPS.

- 1) Select **Advanced > Seldom-used > ERPS > ERPS Setting**.
The **ERPS Setting** interface is displayed.
- 2) Click **Add**.
The **Add New ERPS** interface is displayed.
- 3) Set ERPS ID to be 1. See Figure 3-34.
- 4) Set Port 0 to be 1 and Port 1 to be 2.
- 5) Set Port 0 APS MEP to 1 and Port 1 APS MEP to be 2.
- 6) Set Port 0 SF MEP to be 1 and Port 1 SF MEP to be 2.
- 7) Click **OK**.

Figure 3-34 Add ERPS

Add New ERPS ✕

ERPS ID

Port 0

Port 1

Port 0 APS MEP

Port 1 APS MEP

Port 0 SF MEP

Port 1 SF MEP

Step 6 Click **1** under **ERPSID** to enter the configuration interface.

Figure 3-35 ERPS configuration

ERPS Configuration ✕

Instance Data

| ERPSID | Port 0 | Port 1 | Port 0 APS MEP | Port 1 APS MEP | Port 0 SF MEP | Port 1 SF MEP | Ring Type |
|--------|--------|--------|----------------|----------------|---------------|---------------|------------|
| 1 | 1 | 2 | 1 | 2 | 1 | 2 | Major Ring |

Instance Configuration

| Configured | Guard Time(Ms) | WTR Time | Hold Off Time(Ms) | Version | Revertive | VLANconfig |
|--------------------------------------|----------------|----------|-------------------|---------|--------------------------------------|--|
| ● | 500 | 1min | 0 | v2 | ● | <input style="width: 50px;" type="button" value="VLANconfig"/> |

RPL Configuration

| RPL Role | RPL Port | RPLClear |
|----------|----------|--------------------------|
| None | None | <input type="checkbox"/> |

Instance Command

| Command | CommandPort |
|---------|-------------|
| None | None |

Instance State

| Protection State | State Port0 | State Port1 | Transmit APS | Port0 ReceiveAPS | Port1 Receive APS | WTR Remaining | RPL Unblocked | No APS Received | Port0 BlockStatus | Port1 BlockStatus | FOP Alarm |
|------------------|-------------|-------------|--------------|------------------|-------------------|---------------|--------------------------------------|------------------------------------|-------------------|-------------------|------------------------------------|
| Protected | OK | SF | 2 | 0 | 0 | 0 | ● | ● | Blocked | Unblocked | ● |

- 1) Click **VLANconfig**.
- 2) Click **Add**.

- 3) Set ERPS VLAN to be 2. See Figure 3-36.
- 4) Click **OK**.

Figure 3-36 ERPS VLAN configuration

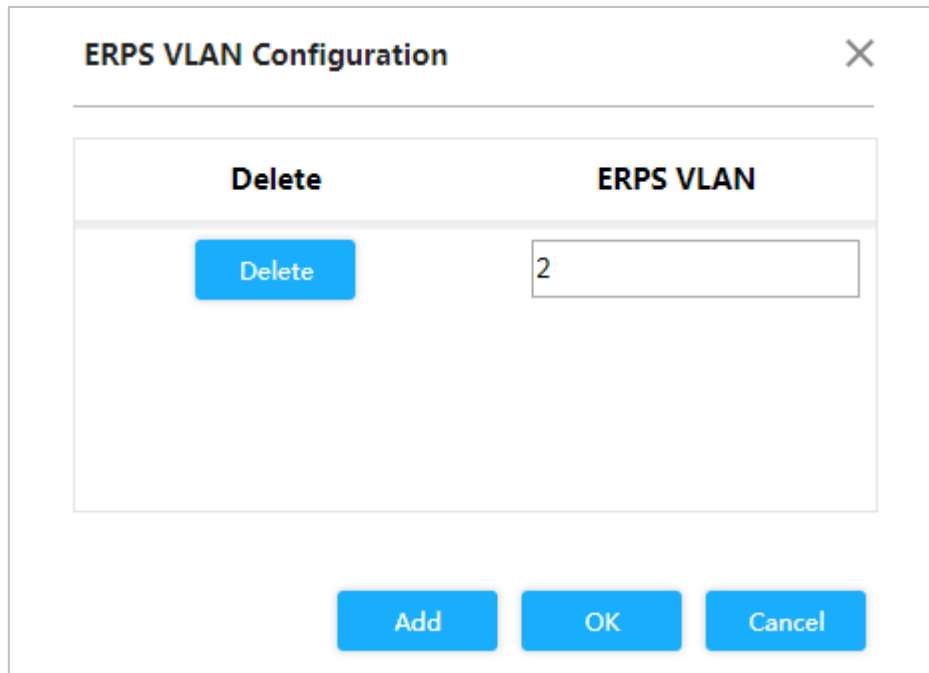

- 5) Set port 2 of switch 1 to be RPL owner in RPL Configuration.

Figure 3-37 Owner port configuration

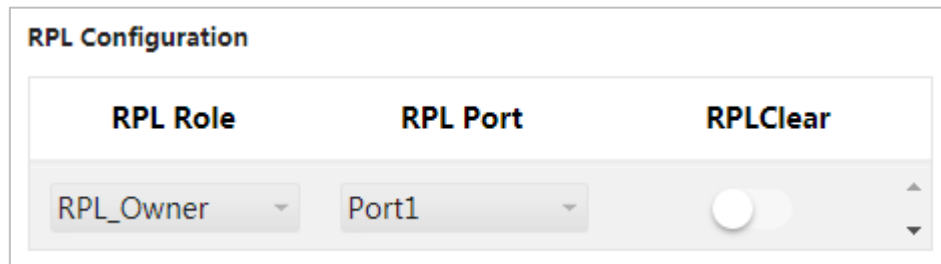

Step 7 Click **OK**.

Step 8 Configure switch 2 and switch 3 in the same way.

Step 9 View the state in **Instance State** on the **ERPS Configuration** interface.

Figure 3-38 Instance state

| Instance State | | | | | | | | | | | | |
|------------------|-------------|-------------|--------------|------------------|------------------|---------------|---------------|-----------------|-------------------|-------------------|-----------|--|
| Protection State | State Port0 | State Port1 | Transmit APS | Port0 ReceiveAPS | Port1 ReceiveAPS | WTR Remaining | RPL Unblocked | No APS Received | Port0 BlockStatus | Port1 BlockStatus | FOP Alarm | |
| Pending | OK | SF | 2 | 0 | 0 | 48680 | ● | ● | Unblocked | Blocked | ● | |

3.2.2 ACL

ACL (Access Control List) is for flow identification. For filtering the packet, the network device needs to configure a series of matching conditions to classify the packets. The conditions can be the source address, destination address, and the port number of the packet.

When the device port receives the packet, it can analyze the packet field according to the ACL rule of the current port. And after the specific packet is identified, the packet is allowed or forbidden to pass according the preset rule.

3.2.2.1 ACL Configuration

- Step 1** Select **Advanced > Seldom-used > ACL > ACL Setting**.
The **ACL Setting** interface is displayed.

Figure 3-39 ACL configuration

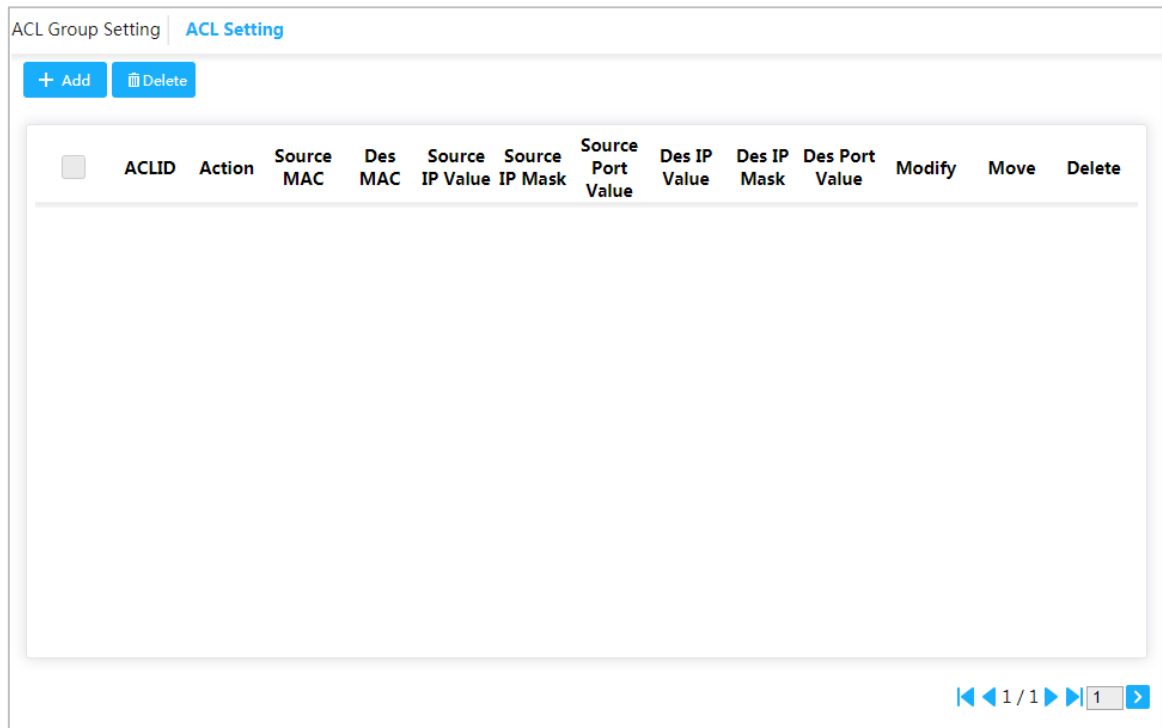

- Step 2** Click **Add**.

Figure 3-40 Add

The 'Add' dialog box is shown with the following fields and options:

- Mode:** MAC ACL (dropdown)
- ACL ID:** (text input)
- Action:** Permit (dropdown)
- Source MAC:** any (dropdown)
- Source MAC Address:** (text input)
- Des MAC:** any (dropdown)
- Destination MAC Address:** (text input)

Below the 'Source MAC Address' field, there is a hint: 'such as 00:23:AE:77:10:53'. At the bottom right, there are two buttons: 'OK' and 'Cancel'.

Step 3 Set the ACL ID, and the range is 1–128.

Step 4 Click **OK**.

3.2.2.2 ACL Group Configuration

Step 1 Select **Advanced > Seldom-used > ACL > ACL Group Setting**.

Figure 3-41 ACL group configuration

| Port | ACLID |
|------|----------------------|
| 1 | <input type="text"/> |
| 2 | <input type="text"/> |
| 3 | <input type="text"/> |
| 4 | <input type="text"/> |
| 5 | <input type="text"/> |
| 6 | <input type="text"/> |
| 7 | <input type="text"/> |

Save Refresh

Step 2 Enter ACL ID. Ensure the ACL ID has been added during ACL configuration.

Step 3 Click **Save**.

3.2.3 Loop Protection

Detect the loop among the ports. After the device has detected the loop, it will break the loop.

Step 1 Select **Advanced > Seldom-used > Loop Protection**.

Figure 3-42 Loop protection

Common

Seldom-used

ERPS

ACL

Loop Protection

Security

IGMP Snooping

Loop Protection

Loop Protection

Step 2 Click to enable Loop Protection

3.2.4 Security

3.2.4.1 User Management

You can add, edit, and delete the user.

Select **Advanced > Seldom-used > Security > User Management**.

Figure 3-43 User management

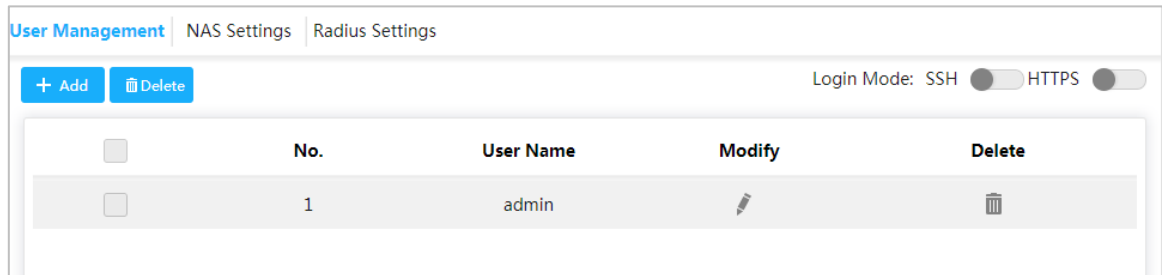

Add user

Step 1 Click **Add**.

Figure 3-44 Add user

The screenshot shows the 'Add User' dialog box. It has a title bar with 'Add User' and a close button (X). The dialog contains three input fields: 'User Name', 'Password', and 'Confirm Password'. The 'Password' field has a strength indicator bar below it. At the bottom right, there are two buttons: 'OK' and 'Cancel'.

Step 2 Enter the user name, password, and confirm password. The password must consist of 8 to 32 non-blank characters and contain at least two types of characters among upper case, lower case, number, and special character (excluding ' " ; &). For example, add the new user test 01.

Step 3 Click **Save**.

The new user test 01 is added.

Figure 3-45 New user added



Modify and Delete User

- Click , and then the **Modify User** interface is displayed.

Figure 3-46 Modify user

The 'Modify User' dialog box has a title bar with a close button (X). It contains three input fields: 'User Name' (a dropdown menu showing 'test01'), 'New Password' (a text input field), and 'Confirm Password' (a text input field). At the bottom right, there are two blue buttons labeled 'OK' and 'Cancel'.

- Click  to delete the user.



You cannot delete the admin user.

SSH

You can enable or disable SSH function.

Click  corresponding to SSH on the upper right corner of the **User Management** interface.

HTTPS

HTTPS (Hyper Text Transfer Protocol over Secure Socket Layer) is the HTTP channel for security target. SSL layer and TLS layer are added to HTTP. SSL and TLS are the security foundation of HTTP, so SSL/TLS are requested for encryption. HTTPS is the URI scheme, and the syntax is similar to HTTP, and it is used for security HTTP data transmission. Built in the web Netscape Navigator, it provides

authentication and encryption communication. It is widely applied in world wide web for security sensitive communication. For example, protect account security and user information.

Click corresponding to HTTPS on the upper right corner of the **User Management** interface to enable HTTPS service.

3.2.4.2 NAS Configuration

NAS (Network Access Server) is a server that allows ISP to provide Internet access service.

Step 1 Select **Advanced > Seldom-used > Security > NAS Settings**.

The **NAS Settings** interface is displayed. See Figure 3-47.

Figure 3-47 NAS configuration

The screenshot shows the 'NAS Settings' configuration page. At the top, there are three tabs: 'User Management', 'NAS Settings' (selected), and 'Radius Settings'. Below the tabs, there are three main settings:

- Mode:** A dropdown menu set to 'Disabled'.
- Reauthentication:** A toggle switch that is turned on, labeled 'Enabled'.

Below these settings is a table with 7 rows, each representing a port configuration. The table has three columns: 'Port', 'Admin State', and 'Port State'.

| Port | Admin State | Port State |
|------|------------------|-------------------|
| 1 | Force Authorized | Globally Disabled |
| 2 | Force Authorized | Globally Disabled |
| 3 | Force Authorized | Globally Disabled |
| 4 | Force Authorized | Globally Disabled |
| 5 | Force Authorized | Globally Disabled |
| 6 | Force Authorized | Globally Disabled |
| 7 | Force Authorized | Globally Disabled |

At the bottom of the interface, there are two buttons: 'Save' and 'Refresh'.

- Step 2 Select **Enabled** in the **Mode** area to enable mirroring function.
- Step 3 Select the **Reauthentication Enabled** box to enable reauthentication.
- Step 4 Set Admin State: Force Authorized, Force Unauthorized, Port based 802.1X or MAC-based Auth.
- Step 5 Click **Save**.

3.2.4.3 Radius Configuration

RADIUS (Remote Authentication Dial-In User Service) is a common protocol to realize AAA (Authentication, Authorization and Accounting).

RADIUS is an information interaction protocol of distributed and C/S construction. It can protect the network from unauthorized visits. It is used in the network that allows remote visits but requests the higher security. It defines the RADIUS packet format and the message transmission mechanism. It stipulates that using UDP as transport layer protocol to encapsulate the RADIUS packet.

At the beginning, RADIUS is the AAA protocol for the dial-up users only. With the development of the user accesses, RADIUS adapts to various access, including Ethernet access and ADSL access. It accesses server through authentication and authorization, and collects records the usage of network source through accounting.

- Step 1 Select **Advanced > Seldom-used > Security > Radius Settings**.

Figure 3-48 Radius configuration

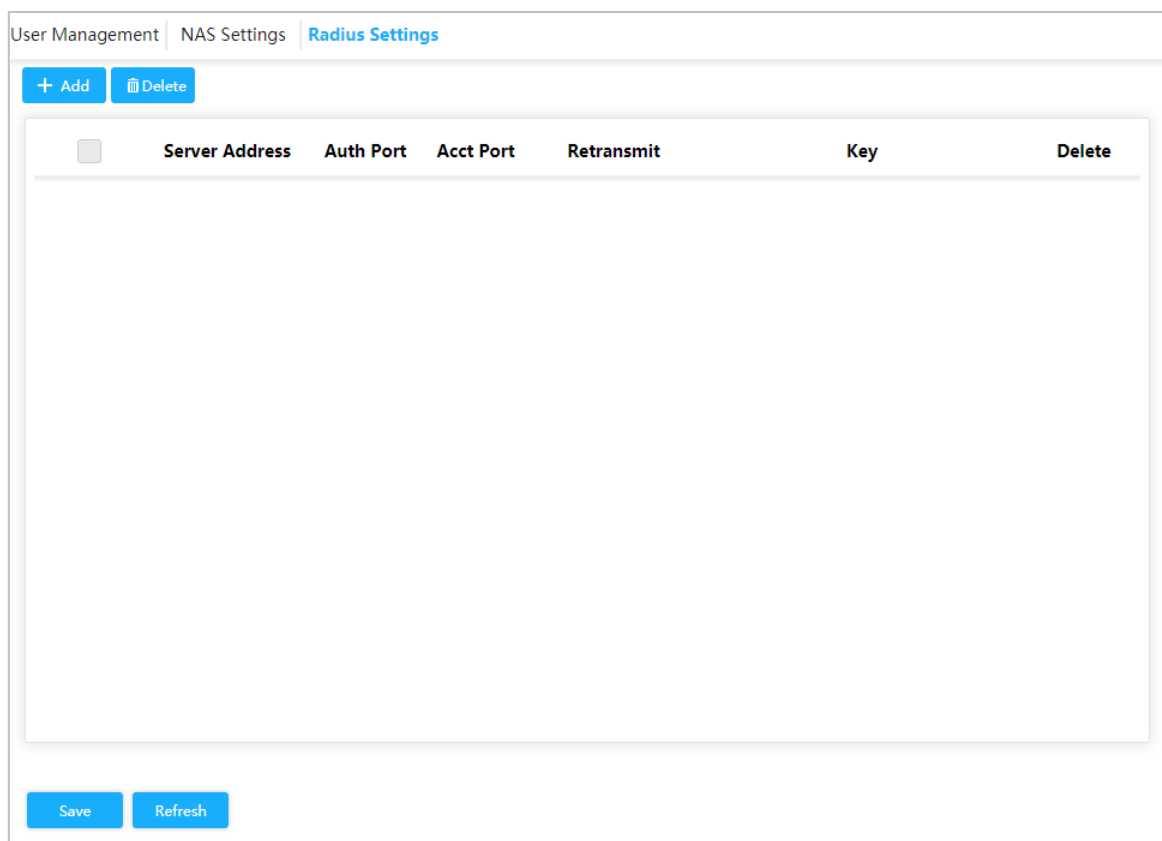

- Step 2 Click **Add**.

Figure 3-49 Add new server

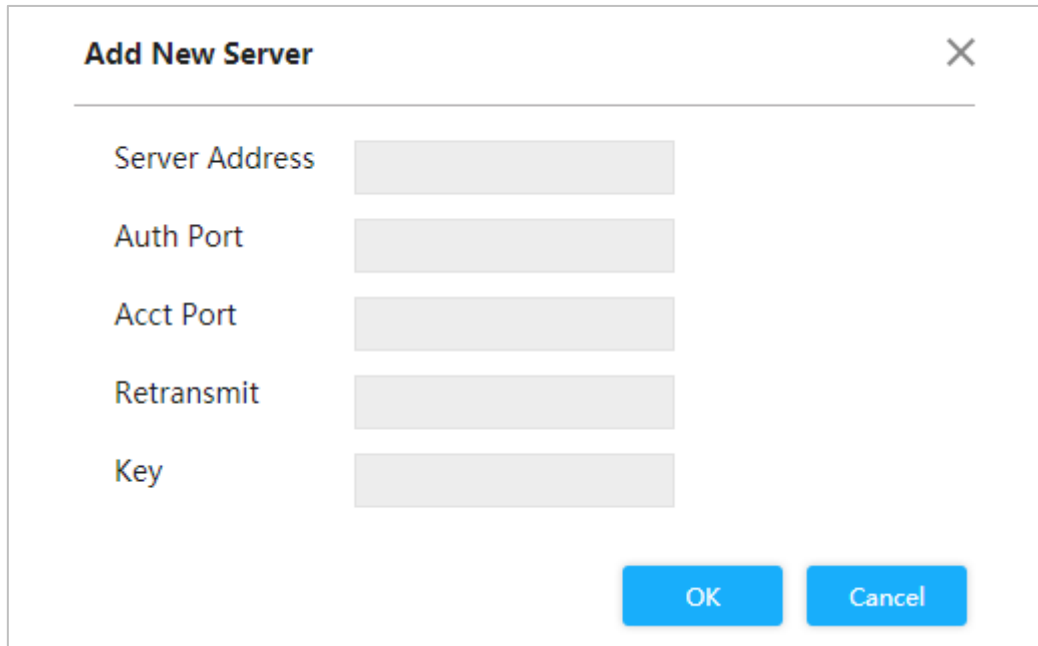

The dialog box titled "Add New Server" contains five input fields: "Server Address", "Auth Port", "Acct Port", "Retransmit", and "Key". At the bottom right, there are two buttons: "OK" and "Cancel".

Step 3 Set the server address, auth port, acct port, retransmit, and key.

Step 4 Click **OK**.

3.2.5 IGMP Snooping

IGMP Snooping (Internet Group Management Protocol Snooping) is the multicast constraint mechanism running on the device of layer 2, for managing and controlling the multicast. Through analyzing the received IGMP packet, the device of layer 2, which runs IGMP Snooping, creates the mapping between the port and the MAC multicast address, and forwards the multicast data according to the mapping.

Step 1 Select **Advanced > Seldom-used > IGMP Snooping**.

Figure 3-50 IGMP snooping

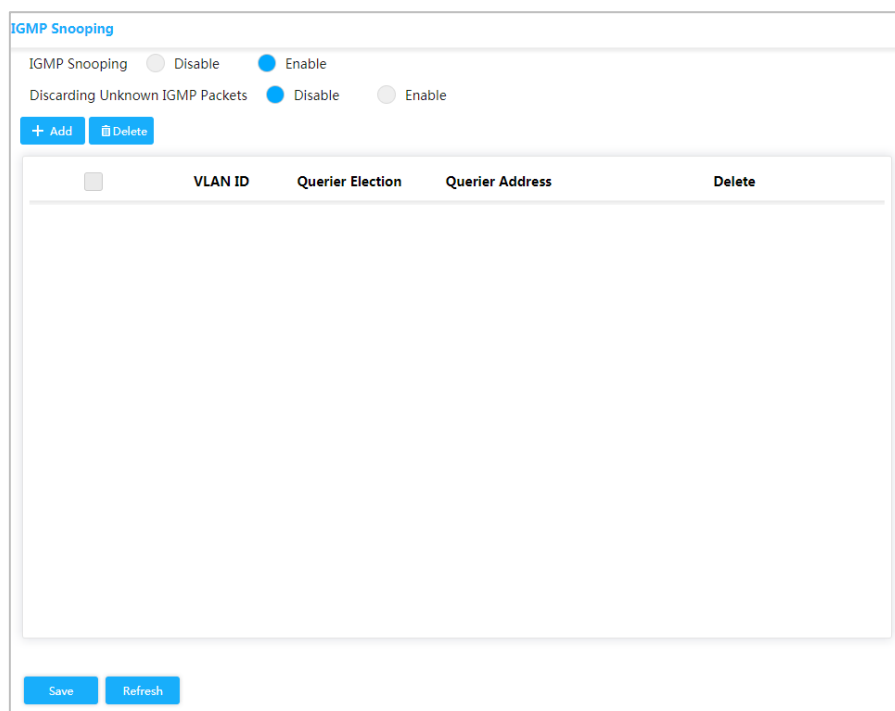

The IGMP Snooping configuration page shows the following settings:

- IGMP Snooping: Enable
- Discarding Unknown IGMP Packets: Disable

Buttons: + Add, Delete

| | VLAN ID | Querier Election | Querier Address | Delete |
|--|---------|------------------|-----------------|--------|
|--|---------|------------------|-----------------|--------|

Buttons: Save, Refresh

- Step 2** Select **Enable** in the **IGMP Snooping** area to enable the function.
- Step 3** Select Disable or Enable in the Discarding Unknown IGMP Packets area.
- Step 4** Click **Add**.

Figure 3-51 Add VLAN

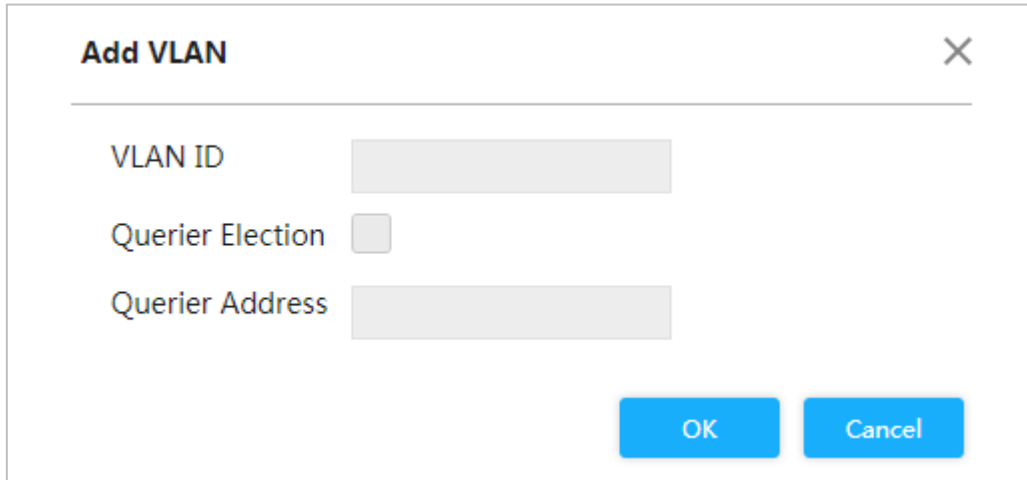

- Step 5** Set VLAN ID and querier address, and select the **Querier Election** box to enable the querier
- Step 6** Click **OK**.

3.2.6 QoS

QoS (Quality of Service) is used to evaluate the capability that server meets customer's service demands. In Internet, what QoS evaluates is the service capability of network forwarding and packet. QoS can evaluate from the different aspects according to the various services provided by the network. QoS evaluates bandwidth, delay, dithering, and packet loss during packet and forwarding.

Congestion

Congestion is common in a complex Internet packet switched environment. See the following example:

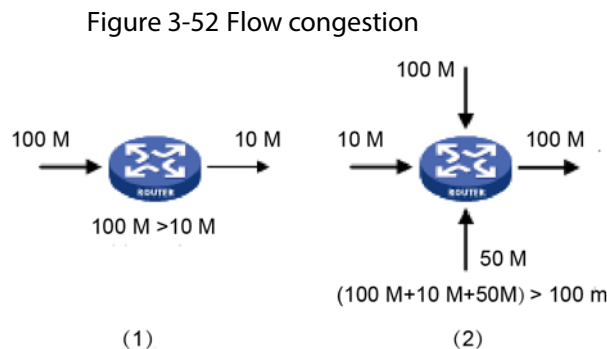

- 1) The packet comes in the device by the high-speed link and exits by low-speed link.
- 2) The packet comes in the device from multiple ports and exits from one port (The speed rate of multiple ports larger than that of the exit port).

If the flow arrives at linear speed, it will encounter the resource chock point, and then the congestion will generate.

Besides the aggression bandwidth, any other resource shortages (such as the shortages of distributive processing time, buffer and memory resources) will cause congestion. Additionally, the

poor control of the arrived flow in a certain time, which leads to the flow exceeding the distributive network resource, is also a factor for generating congestion.

3.2.6.1 Port

Through setting CoS, the priority for packet passing egress port of switch can be decided.

If the congestion occurs at the egress port, the switch will give a CoS value to the packet after it passes the ingress port. The larger the CoS value, the higher the priority.

Step 1 Select **Advanced > Seldom-used > QoS > Port Classification**.

Figure 3-53 Port classification

| Port | CoS | <input type="checkbox"/> DSCP |
|------|-----|-------------------------------|
| 1 | 0 | <input type="checkbox"/> |
| 2 | 0 | <input type="checkbox"/> |
| 3 | 0 | <input type="checkbox"/> |
| 4 | 0 | <input type="checkbox"/> |
| 5 | 0 | <input type="checkbox"/> |
| 6 | 0 | <input type="checkbox"/> |
| 7 | 0 | <input type="checkbox"/> |

Save

Step 2 Set CoS. For example: Set port 1 to be 1, and port 2 to be 2. See Figure 3-54.

Port 1 and port 2 are ingress ports, and port 3 is egress port. The CoS value of port 2 is large than that of port 1, so the data of port 2 will pass port 3 first.

Figure 3-54 Set CoS

| Port | CoS | <input type="checkbox"/> DSCP |
|------|-----|-------------------------------|
| 1 | 1 | <input type="checkbox"/> |
| 2 | 2 | <input type="checkbox"/> |
| 3 | 0 | <input type="checkbox"/> |
| 4 | 0 | <input type="checkbox"/> |
| 5 | 0 | <input type="checkbox"/> |
| 6 | 0 | <input type="checkbox"/> |
| 7 | 0 | <input type="checkbox"/> |

[Save](#)

Step 3 Click **Save**.

3.2.6.2 Port Schedulers

The two modes of port schedulers:

- **Strict Priority.** When congestion occurs, the priority for packet passing egress port of switch depends on the CoS value in **Port Classification**.
- **2-8 Queues Weighted.** When congestion occurs, the priority for packet passing egress port of switch depends on the proportion of total rate.

Step 1 Select **Advanced > Seldom-used > QoS > Port Schedulers**.

Figure 3-55 Port schedulers

| Port | Mode | Q0 | Q1 | Q2 | Q3 | Q4 | Q5 | Q6 | Q7 |
|------|-----------------|----|----|----|----|----|----|----|----|
| 1 | Strict Priority | - | - | - | - | - | - | - | - |
| 2 | Strict Priority | - | - | - | - | - | - | - | - |
| 3 | Strict Priority | - | - | - | - | - | - | - | - |
| 4 | Strict Priority | - | - | - | - | - | - | - | - |
| 5 | Strict Priority | - | - | - | - | - | - | - | - |
| 6 | Strict Priority | - | - | - | - | - | - | - | - |
| 7 | Strict Priority | - | - | - | - | - | - | - | - |

Step 2 Click the port, such as port 1.

The **QoS Egress Port Schedulers and Shapers Port 1** interface is displayed. The CoS of Q0 is 0, and so on.

Figure 3-56 Port configuration

QoS Egress Port Scheduler and Shapers Port 1
✕

Scheduler Mode Strict Priority

| QPort | Ingress Queue Shaper | | | | Queue Scheduler | |
|-------|---------------------------------|------|------|-----------|-----------------|---------|
| | <input type="checkbox"/> Enable | Rate | Unit | Rate-type | Weight | Percent |
| Q0 | <input type="checkbox"/> | 500 | kbps | Line | - | - |
| Q1 | <input type="checkbox"/> | 500 | kbps | Line | - | - |
| Q2 | <input type="checkbox"/> | 500 | kbps | Line | - | - |
| Q3 | <input type="checkbox"/> | 500 | kbps | Line | - | - |
| Q4 | <input type="checkbox"/> | 500 | kbps | Line | - | - |
| Q5 | <input type="checkbox"/> | 500 | kbps | Line | - | - |
| Q6 | <input type="checkbox"/> | 500 | kbps | Line | - | - |
| Q7 | <input type="checkbox"/> | 500 | kbps | Line | - | - |

Egress Queue Shaper

| | | | |
|---------------------------------|------|------|-----------|
| <input type="checkbox"/> Enable | Rate | Unit | Rate-type |
| <input type="checkbox"/> | 500 | kbps | Line |

OK
Cancel

Step 3 Select mode.

- **Strict Priority.** The priority for packet passing egress port of switch depends on the CoS value in **Port Classification**.
- **2-8 Queues Weighted.** When congestion occurs, the priority for packet passing egress port of switch depends on the proportion of total rate.

For example, select **Scheduler Mode** as **2 Queues Weighted**. The max speed limit of port 1 and port 2 is 500 kbps. When congestion occurs, 50% ingress port packet will pass the egress port. See the following for the configuration:

- 1) Select **Scheduler Mode** as **2 Queues Weighted**. See Figure 3-57.
- 2) In **Ingress Queue Shaper**, set the **Rate** of **Q0** and **Q1** to be 500 kbps, and **Rate-type** to be Line.
- 3) In **Egress Queue Shaper**, set the **Rate** to be 500 kbps, and **Rate-type** to be **Line**.
When congestion occurs and the speed of the two ports is 400 kbps, the speed passing the egress port is 250 kbps.

Figure 3-57 Port schedulers

QoS Egress Port Scheduler and Shapers Port 1
✕

Scheduler Mode 2 Queues Weighted

| Ingress Queue Shaper | | | | | Queue Scheduler | |
|----------------------|-------------------------------------|------|------|-----------|-----------------|---------|
| QPort | <input type="checkbox"/> Enable | Rate | Unit | Rate-type | Weight | Percent |
| Q0 | <input checked="" type="checkbox"/> | 500 | kbps | Line | 50 | 50% |
| Q1 | <input checked="" type="checkbox"/> | 500 | kbps | Line | 50 | 50% |
| Q2 | <input type="checkbox"/> | 500 | kbps | Line | - | - |
| Q3 | <input type="checkbox"/> | 500 | kbps | Line | - | - |
| Q4 | <input type="checkbox"/> | 500 | kbps | Line | - | - |
| Q5 | <input type="checkbox"/> | 500 | kbps | Line | - | - |
| Q6 | <input type="checkbox"/> | 500 | kbps | Line | - | - |
| Q7 | <input type="checkbox"/> | 500 | kbps | Line | - | - |

Egress Queue Shaper

| <input checked="" type="checkbox"/> Enable | Rate | Unit | Rate-type |
|--|------|------|-----------|
| <input checked="" type="checkbox"/> | 500 | kbps | Line |

OK
Cancel

Step 4 Click **OK**.

3.2.6.3 Port Shapers

The configuration is the same for port schedulers and port shapers. The only difference is that the port schedulers interface shows the weight value and the port shapers interface shows the speed rate.

Select **Advanced > Seldom-used > QoS > Port Shapers**.

Figure 3-58 Port shapers

| Port | Q0(kbps) | Q1(kbps) | Q2(kbps) | Q3(kbps) | Q4(kbps) | Q5(kbps) | Q6(kbps) | Q7(kbps) | Port Speed(kbps) |
|------|----------|----------|----------|----------|----------|----------|----------|----------|------------------|
| 1 | 500 | 500 | | | | | | | 500 |
| 2 | | | | | | | | | |
| 3 | | | | | | | | | |
| 4 | | | | | | | | | |
| 5 | | | | | | | | | |
| 6 | | | | | | | | | |
| 7 | | | | | | | | | |

3.2.6.4 DSCP-Based

Make sure that you have enabled DSCP before configuring DSCP function.

Step 1 Select **Advanced > Seldom-used > QoS > Port Classification**.

Step 2 Enable DSCP at DSCP port. Suppose port 3 is the egress port.

Figure 3-59 Port classification

Port Classification | Port Schedulers | Port Shapers | DSCP-Based | Storm Policer

| Port | CoS | <input type="checkbox"/> DSCP |
|------|-----|-------------------------------------|
| 1 | 0 | <input type="checkbox"/> |
| 2 | 0 | <input type="checkbox"/> |
| 3 | 0 | <input checked="" type="checkbox"/> |
| 4 | 0 | <input type="checkbox"/> |
| 5 | 0 | <input type="checkbox"/> |
| 6 | 0 | <input type="checkbox"/> |
| 7 | 0 | <input type="checkbox"/> |

Step 3 Click **Save**.

Step 4 Select **Advanced > Seldom-used > QoS > DSCP-Based**.

Step 5 When setting DSCP to be 4 and 8, the CoS is 2 and DPL are 2 and 1.

- 1) When DSCP are 4 and 8, select **Trust** to enable the function. See Figure 3-60.
- 2) When setting DSCP to be 4, CoS is 2 and DPL is 2.
- 3) When setting DSCP to be 8, CoS is 2 and DPL is 1.

The larger the CoS of DSCP, the higher the priority. The corresponding port packet will pass the egress port first.

Figure 3-60 DSCP-Based

Port Classification | Port Schedulers | Port Shapers | **DSCP-Based** | Storm Policer

| DSCP | <input type="checkbox"/> Trust | CoS |
|------|-------------------------------------|-----|
| 0 | <input type="checkbox"/> | 0 |
| 1 | <input type="checkbox"/> | 0 |
| 2 | <input type="checkbox"/> | 0 |
| 3 | <input type="checkbox"/> | 0 |
| 4 | <input checked="" type="checkbox"/> | 2 |
| 5 | <input type="checkbox"/> | 0 |
| 6 | <input type="checkbox"/> | 0 |
| 7 | <input type="checkbox"/> | 0 |
| 8 | <input checked="" type="checkbox"/> | 1 |
| 9 | <input type="checkbox"/> | 0 |

[Save](#)

Step 6 Click **Save**.

3.2.6.5 Storm Policer

Inhibit the three packets, including unicast, multicast and broadcast.

Step 1 Select **Advanced > Seldom-used > QoS > Storm Policer**.

Figure 3-61 Storm policer

Port Classification | Port Schedulers | Port Shapers | DSCP-Based | **Storm Policer**

| Frame Type | <input type="checkbox"/> Enable | Rate | Unit |
|------------|---------------------------------|------|------|
| Unicast | <input type="checkbox"/> | 1 | fps |
| Multicast | <input type="checkbox"/> | 1 | fps |
| Broadcast | <input type="checkbox"/> | 1 | fps |

[Save](#)

Step 2 The port can receive the rate up to 1024 fps. See Figure 3-62.

- In **Unicast**, select the **Enable** box, and enter 1024 in **Rate**. It means that the port can receive the rate up to 1024 fps of unicast packet.
- In **Multicast**, select the **Enable** box, and enter 1024 in **Rate**. It means that the port can receive the rate up to 1024 fps of multicast packet.
- In **Broadcast**, select the **Enable** box, and enter 1024 in **Rate**. It means that the port can receive the rate up to 1024 fps of broadcast packet.

Figure 3-62 Storm policer configuration

Port Classification | Port Schedulers | Port Shapers | DSCP-Based | **Storm Policer**

| Frame Type | <input checked="" type="checkbox"/> Enable | Rate | Unit |
|------------|--|------|------|
| Unicast | <input checked="" type="checkbox"/> | 1024 | fps |
| Multicast | <input checked="" type="checkbox"/> | 1024 | fps |
| Broadcast | <input checked="" type="checkbox"/> | 1024 | fps |

[Save](#)

Step 3 Click **Save**.

3.2.7 SNMP

SNMP (Simple Network Management Protocol) is the standard protocol for network management in Internet, and it is widely applied for management device to access and manage the managed devices. SNMP has the following features:

- It supports intelligent management for network device. By using the network management platform based on SNMP, the network administrator can query the running status and the parameters of the network device, and can configure the parameter, find the error, perform fault diagnosis, and then plan the capacity and create the report.
- SNMP supports to manage the devices of different physical features. SNMP provides only the most basic function library. It makes the management task and the physical feature and the networking technology of the managed device independent, to manage the devices from different manufacturers.

SNMP network provides two elements, NMS and Agent.

- NMS (Network Management System) is the manager in SNMP network, and it provides friendly human-machine interface to help the network administrator to finish most of the network management work.
- Agent is the managed role in SNMP network, and it receives and handles the request packet from NMS. In some emergency circumstances, for example, if the port status changes, Agent can send alarm packet to NMS proactively.

3.2.7.1 Enabling SNMP Function

Step 1 Select **Advanced** > **Seldom-used** > **SNMP**.

Figure 3-63 SNMP

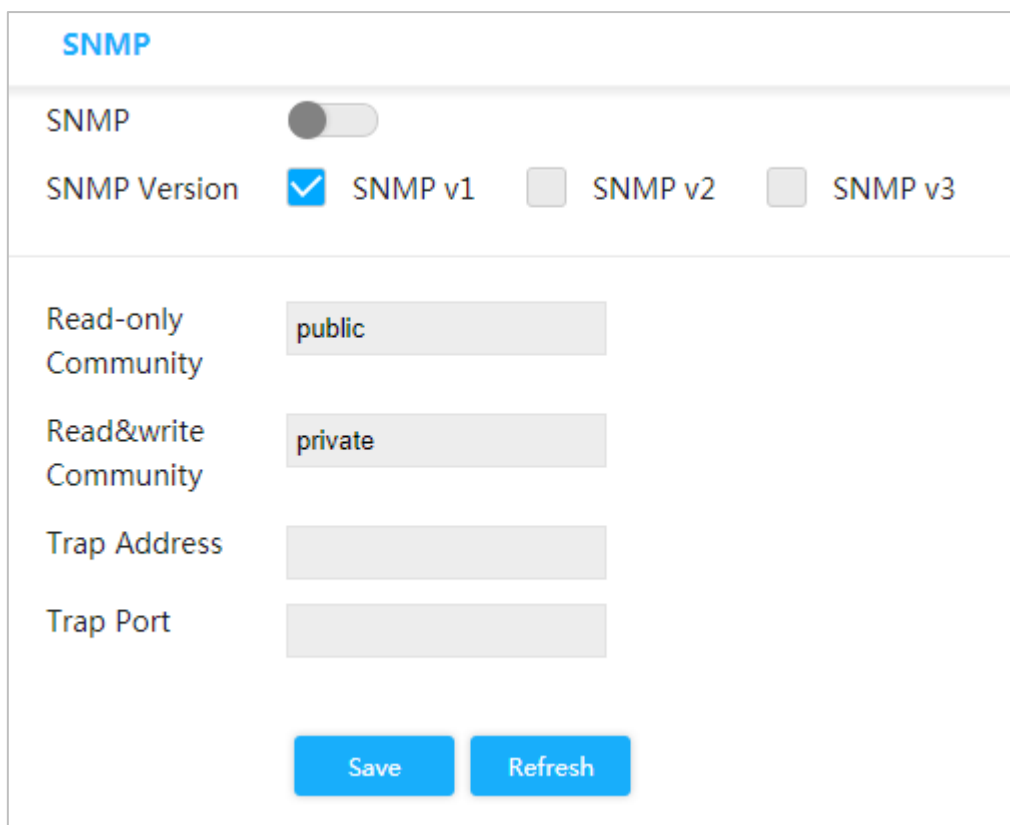

The screenshot shows the SNMP configuration page. At the top, the title "SNMP" is displayed in blue. Below the title, there is a section with a toggle switch for "SNMP" which is currently turned off. Underneath, the "SNMP Version" section has three radio buttons: "SNMP v1" (checked), "SNMP v2", and "SNMP v3". Below this, there are four text input fields: "Read-only Community" with the value "public", "Read&write Community" with the value "private", "Trap Address" (empty), and "Trap Port" (empty). At the bottom of the form, there are two blue buttons: "Save" and "Refresh".

Step 2 Click  in **SNMP** to enable SNMP.



Every SNMP v3 agent has an engine ID as its unique identifier.

3.2.7.2 Configuring SNMP v1/v2

Example: Configure SNMP v1. The configuration of SNMP v2 is the same as that of SNMP v1.

Step 1 Select SNMP v1 in **SNMP Version**.

Step 2 Set the read-only community, read&write community, trap address and trap port.

Step 3 Click **Save**.

3.2.7.3 Configuring SNMP v3

Step 1 Select **SNMP v3** in **SNMP Version**.

Figure 3-64 SNMP v3

SNMP

SNMP

SNMP Version SNMP v1 SNMP v2 SNMP v3

Read-only Community

Read&write Community

Trap Address

Trap Port

Trap Name

Read-only Username

Authentication Type MD5 SHA

Authentication Password

Encryption Type DES AES

Encryption Password

Read&write Username

Authentication Type MD5 SHA

Authentication Password

Encryption Type DES AES

Encryption Password

Step 2 Set the trap address, trap port and trap name.

Step 3 Set the read-only username, authentication type, authentication password, encryption type and encryption password.

Step 4 Set the read&write username, authentication type, authentication password, encryption type and encryption password.

Step 5 Click **Save**.

3.2.8 DHCP Server

DHCP Server is the server for managing DHCP standard in the specific network. DHCP Server is to allocate IP address for the workstation and make sure that the IP address for every workstation is different. DHCP Server simplifies the network management task which should be done manually before.

Generally, in the following scenes, DHCP Server is adopted to allocate IP address.

- The network scale is large. The workload is too heavy if manually configured, and centralized management for network will be difficult.
- The quantity of PC is larger than the quantity of IP address in the network, and it is impossible to allocate a static IP address for every PC. For example, the user quantity that can access network at the same time is limited by ISP, and the user needs to acquire the IP address dynamically.
- Only a small number of PC need the static IP address, and most of the PC do not need the static IP address.

There are three parts of DHCP Server configuration: **VLAN Mode**, **Excluded IP** and **Pool**.

Step 1 Select **Advanced > Seldom-used > DHCP > DHCP Server**.

Figure 3-65 DHCP Server

DHCP Server

Global Mode

VLAN Mode

Excluded IP

| <input type="checkbox"/> | Vlan Range | Delete |
|--------------------------|------------|--------|
|--------------------------|------------|--------|

| <input type="checkbox"/> | Excluded IP | Delete |
|--------------------------|-------------|--------|
|--------------------------|-------------|--------|

Pool

| <input type="checkbox"/> | Name | Type | IP | Subnet mask | Default Gateway | Lease Time | Delete |
|--------------------------|------|------|----|-------------|-----------------|------------|--------|
|--------------------------|------|------|----|-------------|-----------------|------------|--------|

Step 2 Click in **Global Mode**, to enable DHCP Server function.

Step 3 Configure DHCP mode.



Add VLAN interface first. See "3.1.1.2 IP and Route."

- 1) Click **Add** in VLAN Mode.

Figure 3-66 Add VLAN mode

Add VLAN Mode [Close]

Vlan Range [] - []

[OK] [Cancel]

- 2) Enter the VLAN range, such as 2-4.
- 3) Click **OK**.

Step 4 Configure network segment of excluded IP.



Excluded IP refers to the IP reserved for the server, which will not assign to the client.

- 1) Click Add in Excluded IP.

The **Add Excluded IP** interface is displayed. See Figure 3-67.

Figure 3-67 Add excluded IP

Add Excluded IP [Close]

Excluded IP [] - []

[OK] [Cancel]

- 2) Enter the IP address range, such as 192.168.100.2–192.168.100.50.
- 3) Click **OK**.

Step 5 Add DHCP address pool.

- 1) Click **Add** in **Pool**.

The **Add Pool** interface is displayed.

Figure 3-68 Add pool

2) Configure the parameters.

Table 3-7 Pool parameters

| Parameter | Description |
|-------------|--|
| Pool Name | DHCP address pool name, such as "pool01".  Only numbers or letters can be entered, and the length of the string is limited to 1~32. |
| Type | Two types: Network and Host . <ul style="list-style-type: none"> • Network: The network segment of an IP. • Host: A specific IP |
| IP | The IP address of the host or the network. |
| Subnet Mask | The subnet mask of the host or the network. |
| Lease Time | Enter the lease time of the address pool. |
| Gateway | Configure the default gateway of the address pool. |

3) Click **OK**.

3.2.9 LLDP

LLDP (Link Layer Discovery Protocol) is a standard link layer discovery way. It can form its main capabilities, management address, device No. and port No. as TLV (Type Length Value), encapsulate it in LLDPDU (Link Layer Discovery Protocol Data Unit), and release it to its neighbor. The neighbor will keep the received information in the form of standard MIB (Management Information Base), so that the network management can query and judge the communication state of the link.

LLDP

Step 1 Select **Advanced > Seldom-used > LLDP**.

Figure 3-69 LLDP

| Interface | Mode |
|-----------|--------|
| 1 | Enable |
| 2 | Enable |
| 3 | Enable |
| 4 | Enable |
| 5 | Enable |
| 6 | Enable |
| 7 | Enable |

Save

Step 2 Set LLDP mode.

- Select **Enable**: Both send and receive LLDP packet.
- Select **Disable**: Neither send nor receive LLDP packet.
- Select **Rx only**: Only receive LLDP packet.
- Select **Tx only**: Only send LLDP packet.

Step 3 Click **Save**.

View the LLDP Neighbor Information.

Select **Advanced > Seldom-used > LLDP > LLDP Neighbor**.

Figure 3-70 LLDP neighbor

| LLDP Remote Device Summary | | | | | |
|----------------------------|---------------|-------------------------|-------------|----------------------|--|
| Local Interface | Port ID | Port Description | System Name | System Capabilities | Management Address |
| GigabitEthernet 1/8 | Ethernet1/0/5 | Ethernet1/0/5 Interface | SW1 | Bridge(+), Router(+) | 192.168.1.1 (IPv4) - if-index:12 OID: 0.0 |

3.2.10 485 Configuration

Transmit the data of asynchronous serial port RS-232/485 transparently through Ethernet.

Select **Advanced > Seldom-used > 485 Config**.

Figure 3-71 485 configuration

485 Config

Serial Index:

Enable: ON OFF

Network Setting:

Protocol Type:

IP Address:

IP Port:

Timeout(s):

Serial Setting:

Serial Speed:

Data Bits:

Parity Bits:

Stop Bits:

3.2.11 PoE

PoE (Power over Ethernet) is the function that through Ethernet RJ-45 port, the device can provide power for the external PD (Powered Device) remotely with twisted pair. PoE function helps to centralize power supply and facilitate backup. The network terminal does not need the external power source anymore, and one network cable is enough, It conforms to the standards of IEEE 802.3af, IEEE 802.3at, and IEEE 802.3bt, adopting the power port globally agreed. It can be applied in IP telephone, wireless AP (Access Point), portable device charger, card reader, network camera, data collection, and so on.



- Non-PoE switches do not support this function.
- Only some models of PoE switches comply with the IEEE 802.3bt standard, and BT supports Max. 90W. Please refer to the actual situation.

3.2.11.1 PoE Parameters

Configure reserved power, warning power, and enable or disable PoE.

Step 1 Select **Advanced > Seldom-used > PoE > PoE Settings**.

Figure 3-72 PoE settings

PoE Settings | Green PoE | Legacy Support | PD Alive | PoE Event Statistics

PoE Settings

Total Power: 190 W

Available Power: 171 W

Overload Power: 190 W

Power Status

Consumed: 0 W

Remaining: 190 W

Reserved: 0 W

Port Status and Control

| Port | Consumed | <input checked="" type="checkbox"/> Enable | PD Class | Status |
|------|----------|--|----------|----------------|
| 1 | 0 | <input checked="" type="checkbox"/> | - | PoE turned OFF |
| 2 | 0 | <input checked="" type="checkbox"/> | - | PoE turned OFF |
| 3 | 0 | <input checked="" type="checkbox"/> | - | PoE turned OFF |
| 4 | 0 | <input checked="" type="checkbox"/> | - | PoE turned OFF |
| 5 | 0 | <input checked="" type="checkbox"/> | - | PoE turned OFF |
| 6 | 0 | <input checked="" type="checkbox"/> | - | PoE turned OFF |
| 7 | 0 | <input checked="" type="checkbox"/> | - | PoE turned OFF |
| 8 | 0 | <input checked="" type="checkbox"/> | - | PoE turned OFF |

Save Refresh

- Step 2 In **PoE Settings**, you can view the total power of the 4 ports, and configure available power and overload power.
- Step 3 In **Power Status**, you can view consumed power, remaining power and reserved power.
- Step 4 In **Port Status and Control**, select the **Enable** box to enable or disable PoE of the corresponding port.
- Step 5 Click **Save**.

3.2.11.2 Green PoE

Set PoE off and on time.

- Step 1 Select **Advanced > Seldom-used > PoE > Green PoE**.

Figure 3-73 Green PoE

| Port | Enable |
|------|--------------------------|
| 1 | <input type="checkbox"/> |
| 2 | <input type="checkbox"/> |
| 3 | <input type="checkbox"/> |
| 4 | <input type="checkbox"/> |
| 5 | <input type="checkbox"/> |
| 6 | <input type="checkbox"/> |
| 7 | <input type="checkbox"/> |
| 8 | <input type="checkbox"/> |

- Step 2 Set **PoE Off Time** and **PoE On Time**.
- Step 3 Select the **Enable** box and click **Save**.

3.2.11.3 Legacy Support

Enable **Legacy Support** in case of non-standard powered device.



Non-standard powered device means that the device supports 48V PoE power supply, but does not conform to IEEE 802.3af/at.

- Step 1 Select **Advanced > Seldom-used > PoE > Legacy Support**.

Figure 3-74 Legacy support

PoE Settings | Green PoE | **Legacy Support** | PD Alive | PoE Event Statistics

The port will provide power compulsorily no matter whether the connected PD device conforms to standard or not after Legacy Support is enabled. Please use it carefully!
You can only use one between mandatory PoE power supply and PoE watchdog each time.

| Port | Enable |
|------|-------------------------------------|
| 1 | <input checked="" type="checkbox"/> |
| 2 | <input type="checkbox"/> |
| 3 | <input type="checkbox"/> |
| 4 | <input type="checkbox"/> |
| 5 | <input type="checkbox"/> |
| 6 | <input type="checkbox"/> |
| 7 | <input type="checkbox"/> |
| 8 | <input type="checkbox"/> |

Step 2 Select the **Enable** box for the corresponding port.

Step 3 Click **Save**.

3.2.11.4 PoE Watchdog

With PoE watchdog enabled, you can monitor PD and keep it online, and check the status of PD devices every 60 s. If there is no data transmission, the PoE port will be automatically powered off and restarted. Mandatory PoE power supply and PoE watchdog cannot be used at the same time.

Select **Advanced > Seldom-used > PoE > PD Alive**, select the check box of the corresponding port, and then click **Save**.

Figure 3-75 PoE watchdog

PoE Settings | Green PoE | Legacy Support | **PD Alive** | PoE Event Statistics

You can only use one between mandatory PoE power supply and PoE watchdog each time.

| Port | Enable |
|------|-------------------------------------|
| 1 | <input checked="" type="checkbox"/> |
| 2 | <input type="checkbox"/> |
| 3 | <input type="checkbox"/> |
| 4 | <input type="checkbox"/> |
| 5 | <input type="checkbox"/> |
| 6 | <input type="checkbox"/> |
| 7 | <input type="checkbox"/> |
| 8 | <input type="checkbox"/> |

3.2.11.5 Viewing PoE Event Statistics

Select **Advanced > Seldom-used > PoE > PoE Event Statistic** to view PoE event statistics.

Figure 3-76 PoE event statistic

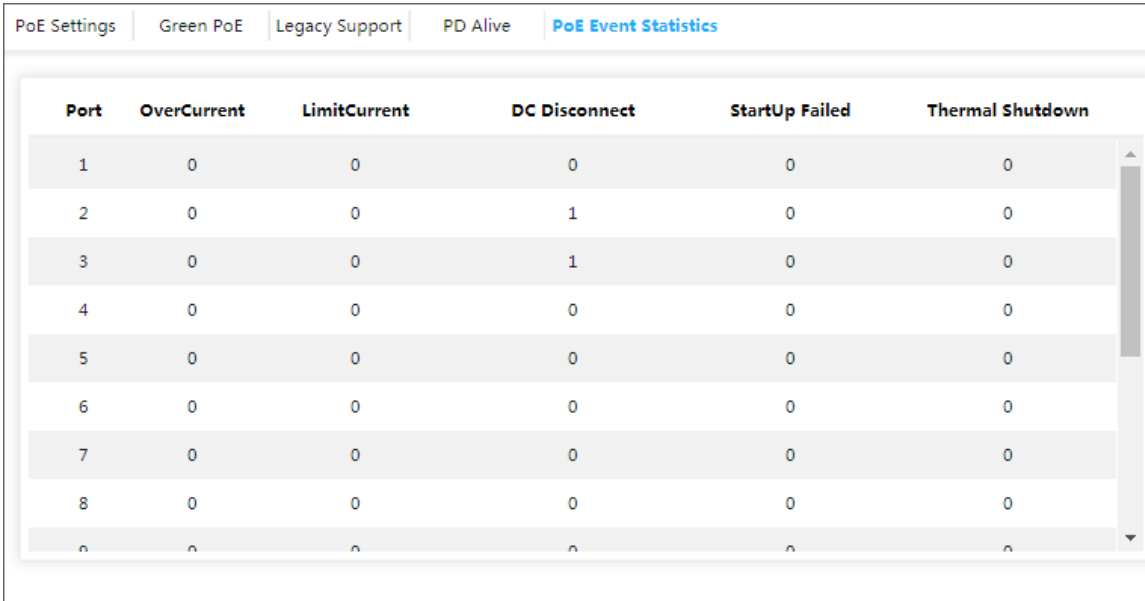

The screenshot shows a web interface with a navigation bar at the top containing tabs: PoE Settings, Green PoE, Legacy Support, PD Alive, and PoE Event Statistics (which is selected). Below the navigation bar is a table with the following data:

| Port | OverCurrent | LimitCurrent | DC Disconnect | StartUp Failed | Thermal Shutdown |
|------|-------------|--------------|---------------|----------------|------------------|
| 1 | 0 | 0 | 0 | 0 | 0 |
| 2 | 0 | 0 | 1 | 0 | 0 |
| 3 | 0 | 0 | 1 | 0 | 0 |
| 4 | 0 | 0 | 0 | 0 | 0 |
| 5 | 0 | 0 | 0 | 0 | 0 |
| 6 | 0 | 0 | 0 | 0 | 0 |
| 7 | 0 | 0 | 0 | 0 | 0 |
| 8 | 0 | 0 | 0 | 0 | 0 |
| 9 | 0 | 0 | 0 | 0 | 0 |

4 Maintenance

Take 4-port PoE switch for example. The maintenance interface is different depending on the models of switch. The actual interface shall prevail.

4.1 System Reboot

Step 1 Select **Maintain > Common > System Reboot**.

Figure 4-1 System reboot

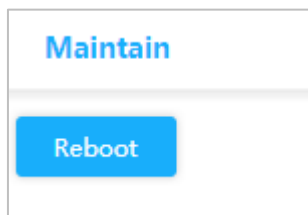

Step 2 Click **Reboot**.

Step 3 Click **Confirm**, and the device reboots.

4.2 Restoring Default Settings

You can restore all the switch configurations to the factory defaults, except the VLAN1 IP address of the switch.

Step 1 Select **Maintain > Common > Restore Default**.

Figure 4-2 Restore default

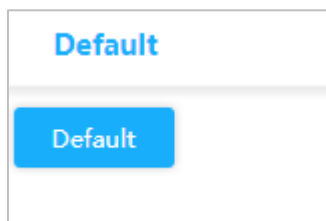

Step 2 Click **Default**.

All the configurations, except VLAN1 IP address of the switch, have been restored to factory defaults.

4.3 Managing Configuration

4.3.1 Exporting Configuration File

Step 1 Select **Maintain > Common > Config Manage > Export**.

Figure 4-3 Export

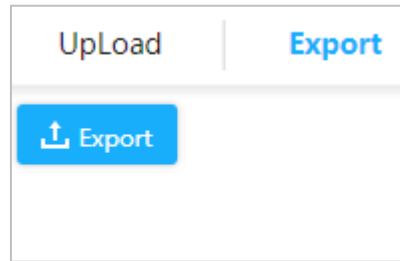

Step 2 Click **Export** to export configuration file.

4.3.2 Uploading Configuration File

Step 1 Select **Maintain > Common > Config Manage > UpLoad**.

Figure 4-4 Upload



Step 2 Click **Browse...**, and select the configuration file to upload.

Step 3 Click **UpLoad**.

Step 4 Restart the device, and the configuration will take effect.

4.4 Software Update

Step 1 Select **Maintain > Common > Software Update**.

Figure 4-5 Upgrade



Step 2 Click **Browse**, and select the file in .mif format to upload.



If the format of the update file is wrong, the system will show the following prompt.

Figure 4-6 Error prompt



Step 3 Click **Upgrade**.

Step 4 Click **Confirm** on the pop-up box.

The device restarts after the upgrade is finished.

Figure 4-7 Confirm update

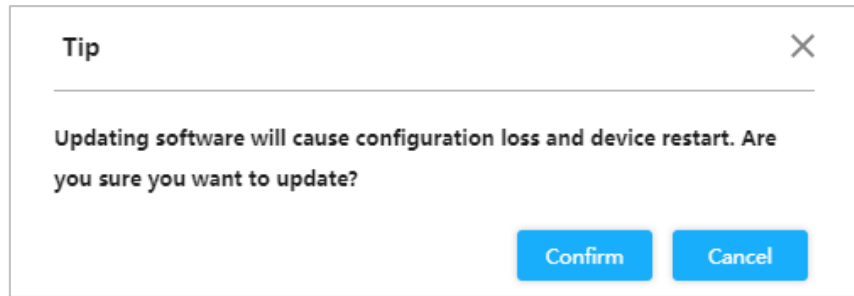

4.5 Mirroring

Port mirroring is also called port monitoring. Port monitoring is the data package acquiring technology that through configuring switch, data package from one or several ports (mirroring source ports) can be copied to a specific port (mirroring destination port). The mirroring destination port connects to a PC where data package analyzing software is installed, and it can analyze the received data package for network monitoring and troubleshooting.

Step 1 Select **Maintain > Common > Mirror**.

Figure 4-8 Mirror

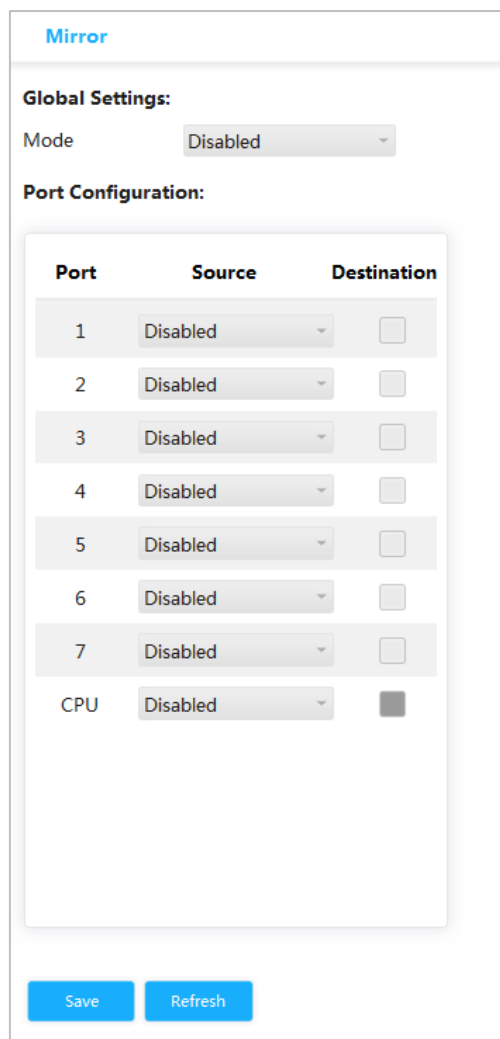

Step 2 In **Global Settings**, select **Enabled** in **Mode** to enable mirroring.

Step 3 In **Port Configuration**, select **Source** or **Destination** according to the actual situation.

- Select the following four ways for source port.
 - ◇ Both: Enable the port as the source address of mirror.
 - ◇ Disable: Disable the port as the source address of mirror.
 - ◇ Rx only: The port only mirrors receiving data, rather than sending data.
 - ◇ Tx only: The port only mirrors sending data, rather than receiving data.
- Select the **Destination** box to set the port to be destination.

Step 4 Click **Save**.

4.6 Ping

With Ping protocol, you can check whether the device with a specified IP address can be accessed, and check whether the network connection fails.

Step 1 Select **Maintain > Common > Ping**.

Figure 4-9 Ping

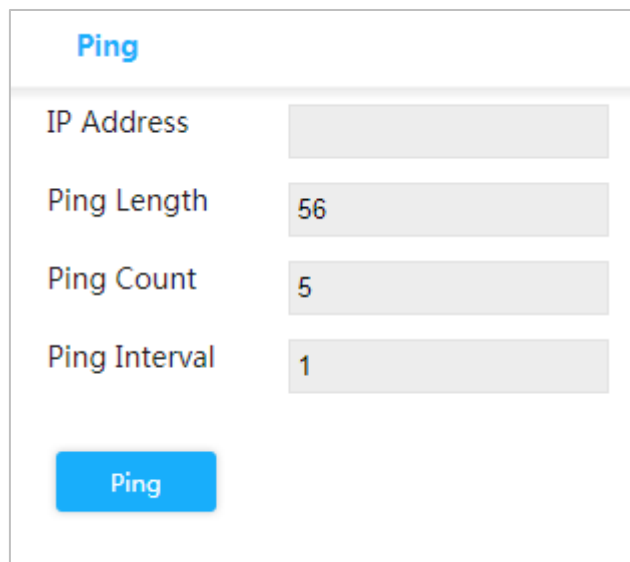

| Ping | |
|---------------|---------------------------------|
| IP Address | <input type="text"/> |
| Ping Length | <input type="text" value="56"/> |
| Ping Count | <input type="text" value="5"/> |
| Ping Interval | <input type="text" value="1"/> |

Step 2 Enter the IP address, and then click **Ping**.

4.7 Functions of Network Management System

4.7.1 Enabling Function and Logging in to Platform

The functions of network management system is to support iLinksView network management platform. You can enable or disable the network management function and change the username and password.



The username and password must be the same as those of iLinksView network management platform.

Network management function is enabled by default. Here are the default username and password.

Username: admin

Password: lt_91_il_02_nmp

Figure 4-10 iLinksView

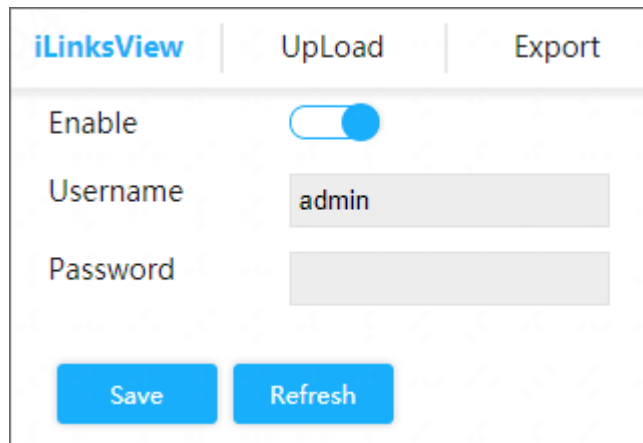

4.7.2 Exporting Network Management Configuration File

You can export network management configuration file.

Step 1 Select **Maintain > Common > iLinksView > Export**.

Figure 4-11 Export configuration file

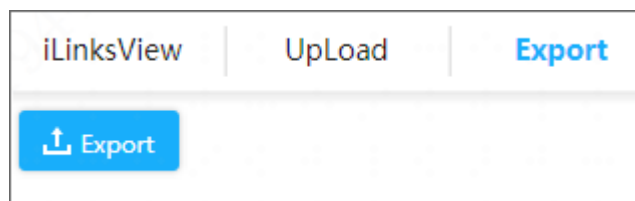

Step 2 Click **Export**.

4.7.3 Uploading Network Management Configuration File

You can upload network management configuration file.

Step 1 Select **Maintain > Common > iLinksView > Upload**.

Figure 4-12 Upload configuration file

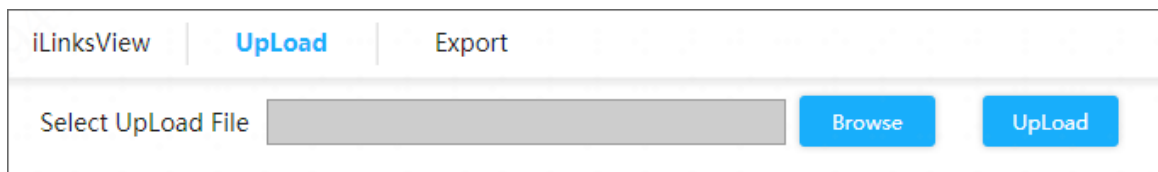

Step 2 Click **Browse** to select configuration file.

Step 3 Click **Upload**.

Step 4 Restart the device, and the configuration takes effect.

Appendix 1 Cybersecurity Recommendations

Cybersecurity is more than just a buzzword: it's something that pertains to every device that is connected to the internet. IP video surveillance is not immune to cyber risks, but taking basic steps toward protecting and strengthening networks and networked appliances will make them less susceptible to attacks. Below are some tips and recommendations on how to create a more secured security system.

Mandatory actions to be taken for basic equipment network security:

1. Use Strong Passwords

Please refer to the following suggestions to set passwords:

- The length should not be less than 8 characters;
- Include at least two types of characters; character types include upper and lower case letters, numbers and symbols;
- Do not contain the account name or the account name in reverse order;
- Do not use continuous characters, such as 123, abc, etc.;
- Do not use overlapped characters, such as 111, aaa, etc.;

2. Update Firmware and Client Software in Time

- According to the standard procedure in Tech-industry, we recommend to keep your equipment (such as NVR, DVR, IP camera, etc.) firmware up-to-date to ensure the system is equipped with the latest security patches and fixes. When the equipment is connected to the public network, it is recommended to enable the "auto-check for updates" function to obtain timely information of firmware updates released by the manufacturer.
- We suggest that you download and use the latest version of client software.

"Nice to have" recommendations to improve your equipment network security:

1. Physical Protection

We suggest that you perform physical protection to equipment, especially storage devices. For example, place the equipment in a special computer room and cabinet, and implement well-done access control permission and key management to prevent unauthorized personnel from carrying out physical contacts such as damaging hardware, unauthorized connection of removable equipment (such as USB flash disk, serial port), etc.

2. Change Passwords Regularly

We suggest that you change passwords regularly to reduce the risk of being guessed or cracked.

3. Set and Update Passwords Reset Information Timely

The equipment supports password reset function. Please set up related information for password reset in time, including the end user's mailbox and password protection questions. If the information changes, please modify it in time. When setting password protection questions, it is suggested not to use those that can be easily guessed.

4. Enable Account Lock

The account lock feature is enabled by default, and we recommend you to keep it on to guarantee the account security. If an attacker attempts to log in with the wrong password several times, the corresponding account and the source IP address will be locked.

5. Change Default HTTP and Other Service Ports

We suggest you to change default HTTP and other service ports into any set of numbers between 1024–65535, reducing the risk of outsiders being able to guess which ports you are using.

6. Enable HTTPS

We suggest you to enable HTTPS, so that you visit Web service through a secure communication channel.

7. MAC Address Binding

We recommend you to bind the IP and MAC address of the gateway to the equipment, thus reducing the risk of ARP spoofing.

8. Assign Accounts and Privileges Reasonably

According to business and management requirements, reasonably add users and assign a minimum set of permissions to them.

9. Disable Unnecessary Services and Choose Secure Modes

If not needed, it is recommended to turn off some services such as SNMP, SMTP, UPnP, etc., to reduce risks.

If necessary, it is highly recommended that you use safe modes, including but not limited to the following services:

- SNMP: Choose SNMP v3, and set up strong encryption passwords and authentication passwords.
- SMTP: Choose TLS to access mailbox server.
- FTP: Choose SFTP, and set up strong passwords.
- AP hotspot: Choose WPA2-PSK encryption mode, and set up strong passwords.

10. Audio and Video Encrypted Transmission

If your audio and video data contents are very important or sensitive, we recommend that you use encrypted transmission function, to reduce the risk of audio and video data being stolen during transmission.

Reminder: encrypted transmission will cause some loss in transmission efficiency.

11. Secure Auditing

- Check online users: we suggest that you check online users regularly to see if the device is logged in without authorization.
- Check equipment log: By viewing the logs, you can know the IP addresses that were used to log in to your devices and their key operations.

12. Network Log

Due to the limited storage capacity of the equipment, the stored log is limited. If you need to save the log for a long time, it is recommended that you enable the network log function to ensure that the critical logs are synchronized to the network log server for tracing.

13. Construct a Safe Network Environment

In order to better ensure the safety of equipment and reduce potential cyber risks, we recommend:

- Disable the port mapping function of the router to avoid direct access to the intranet devices from external network.
- The network should be partitioned and isolated according to the actual network needs. If there are no communication requirements between two sub networks, it is suggested to use VLAN, network GAP and other technologies to partition the network, so as to achieve the network isolation effect.
- Establish the 802.1x access authentication system to reduce the risk of unauthorized access to private networks.
- Enable IP/MAC address filtering function to limit the range of hosts allowed to access the device.