



HIKVISION



32/40-inch LCD Display Unit

User Manual

G6AUM31500009

Thank you for purchasing our product. If there is any question or request, please do not hesitate to contact us. This manual may contain several technically incorrect places or printing errors, and the content is subject to change without notice. The updates will be added into the new version of this manual. We will readily improve or update the products or described in the manual.

Regulatory Information

EU Conformity Statement



This product and - if applicable - the supplied accessories too are marked with "CE" and comply therefore with the applicable harmonized European standards listed under the EMC Directive 2014/30/EU, the LVD Directive 2014/35/EU, the ROHS Directive 2011/65/EU.



2002/96/EC (WEEE directive): Products marked with this symbol cannot be disposed of as unsorted municipal waste in the European Union. For proper recycling, return this product to your local supplier upon the purchase of equivalent new equipment, or dispose of it at designated collection points. For more information see: www.recyclethis.info.



2006/66/EC (battery directive): This product contains a battery that cannot be disposed of as unsorted municipal waste in the European Union. See the product documentation for specific battery information. The battery is marked with this symbol, which may include lettering to indicate cadmium (Cd), lead (Pb), or mercury (Hg). For proper recycling, return the battery to your supplier or to a designated collection point. For more information see: www.recyclethis.info.

Hikvision® 32/40-inch LCD Display Unit User's Manual

This manual, as well as the software described in it, is furnished under license and may be used or copied only in accordance with the terms of such license. The content of this manual is furnished for informational use only, is subject to change without notice, and should not be construed as a commitment by Hikvision Digital Technology Co., Ltd. (Hikvision). Hikvision assumes no responsibility or liability for any errors or inaccuracies that may appear in the book.

Except as permitted by such license, no part of this publication may be reproduced, stored in a retrieval system, or transmitted, in any form or by any means, electronic, mechanical, recording, or otherwise, without the prior written permission of Hikvision.

HIKVISION MAKES NO WARRANTIES, EXPRESS OR IMPLIED, INCLUDING WITHOUT LIMITATION THE IMPLIED WARRANTIES OF MERCHANTABILITY AND FITNESS FOR A PARTICULAR PURPOSE, REGARDING THE HIKVISION SOFTWARE. HIKVISION DOES NOT WARRANT, GUARANTEE, OR MAKE ANY REPRESENTATIONS REGARDING THE USE OR THE RESULTS OF THE USE OF THE HIKVISION SOFTWARE IN TERMS OF ITS CORRECTNESS, ACCURACY, RELIABILITY, CURRENTNESS, OR OTHERWISE. THE ENTIRE RISK AS TO THE RESULTS AND PERFORMANCE OF THE HIKVISION SOFTWARE IS ASSUMED BY YOU. THE EXCLUSION OF IMPLIED WARRANTIES IS NOT PERMITTED BY SOME STATES. THE ABOVE EXCLUSION MAY NOT APPLY TO YOU.

IN NO EVENT WILL HIKVISION, ITS DIRECTORS, OFFICERS, EMPLOYEES, OR AGENTS BE LIABLE TO YOU FOR ANY CONSEQUENTIAL, INCIDENTAL, OR INDIRECT DAMAGES (INCLUDING DAMAGES FOR LOSS OF BUSINESS PROFITS, BUSINESS INTERRUPTION, LOSS OF BUSINESS INFORMATION, AND THE LIKE) ARISING OUT OF THE USE OR INABILITY TO USE THE HIKVISION SOFTWARE EVEN IF HIKVISION HAS BEEN ADVISED OF THE POSSIBILITY OF SUCH DAMAGES. BECAUSE SOME STATES DO NOT ALLOW THE EXCLUSION OR LIMITATION OF LIABILITY FOR CONSEQUENTIAL OR INCIDENTAL DAMAGES, THE ABOVE LIMITATIONS MAY NOT APPLY TO YOU.

TABLE OF CONTENTS

Important safeguards	2
Introduction	4
Features	5
Assembling the monitor	6
Wall hanging Standard	7
The function of the interface	7
Front panel controls	8
Control panel	8
Changing a monitor parameter	9
Hot keys	9
Adjustment procedure	9
OSD function	10
VGA menu	10
Cam menu	12
HDMI menu	13
DVI menu	15
Self-diagnosis	21
Troubleshooting	22
Specifications	23

IMPORTANT SAFEGUARDS

1. Installation cautions

- Do not block any ventilation openings.
- Always ensure that the monitor is located in a well-ventilated area to prevent the unit from overheating.
- Only use accessories specified by the manufacturer or those sold with the product
- Avoid operating or placing the monitor in the following environments: extremes of temperatures, both hot and cold; high humidity; direct sunlight; excessively dusty surroundings; avoid close proximity to other equipment that generates a strong magnetic field

2. Water and moisture

Do not use this appliance near water. To reduce the risk of fire or electric shock, do not expose this unit to rain or moisture.

3. Power cord and power cord protection

Power cords should be routed so that they are not likely to be walked on or pinched. Pay particular attention to the location of cords and plugs, convenience receptacles, and the point of exit from the appliance.

4. Product care

Do not touch the screen directly with fingers. The oils from your skin may leave marks on the surface of the screen, which are difficult to be removed and may damage the screen permanently. Do not apply pressure to the screen.

5. Cleaning

Clean only with a dry cloth.

6. Servicing

Do not attempt to service this unit yourself. Opening or removing covers may expose you to dangerous voltage or other hazards. Refer all servicing to qualified service personnel.

7. Lightning

For added protection during a lightning storm or when this unit is left unattended and unused for long periods of time, unplug the unit from the wall outlet and disconnect the cable system. This will prevent damage to the unit due to lightning and power line surges.

IMPORTANT SAFEGUARDS

8. Mains plug (2 pin/3 pin)

- Do not remove the grounding or earth connection from the power supply /mains plug.
- Always remember to unplug the monitor from the power supply under the following circumstances if the monitor will not be used for a long period of time, if the power supply cable or plug/connector is damaged or if the monitor housing is damaged or broken.

CAUTION: Do not attempt to dismantle this product. Any attempt to dismantle or remove the covers from this product will invalidate the warranty and may also result in serious injury.

INTRODUCTION

This manual explains how to correctly install, operate and get the best performance from your monitor. Please read this user manual carefully before installing your monitor then keep it near your monitor for quick reference. First, please check that the contents of the box correspond with the following checklist:

- LCD monitor
- Power cord
- VGA cable
- HDMI cable(optional)
- Audio cable(optional)
- Remote control(optional)
- User manual

If any item is missing or damaged, please contact your dealer. Please keep the box and packing materials so that you may properly store or transport your monitor.

FEATURES

- The monitor is designed for use in a small work area or for those who need more work space on the desk.
- The convenient and user-friendly onscreen display allows for easy and accurate adjustments of screen size, position and screen color.
- The monitor complies with the VESA Display Data Channel (DDC) specification for Plug and Play compatibility. Advanced microcircuitry makes setup and configuration fast and effortless.
- The monitor features Advanced Color Controls for fine-tuning to meet your own personal tastes or application requirements. Use the on-screen controls to adjust the color temperature,
- RGB gain value for the best possible screen color and intensity.
- Press the Menu button and activate the Self-Diagnosis menu to determine whether your monitor is functioning normally, not receiving a signal or is receiving a signal that is out of scanning range.
- Activate the higher refresh rates of the monitor to stabilize the screen and eliminate the annoying flicker that contributes to eye-strain and headaches.
- The monitor supports the optimal display performance with 1920x1080 @ 60 Hz
- The monitor can be connected to various types of video devices with supporting video input signals such as Composite video (CVBS), and Separate video.
- The internal stereo speakers produce a good quality audio sound.

ASSEMBLING THE MONITOR

The monitors are designed for use on a desktop.

The arm of the monitor stand is shipped preinstalled on the monitor.

To assemble the monitor:

1. Put a smooth pad or cloth on a level surface. Place the monitor on it facing downwards.
2. Insert the arm of the monitor stand of the monitor into the pedestal foot provided.
See figures below.

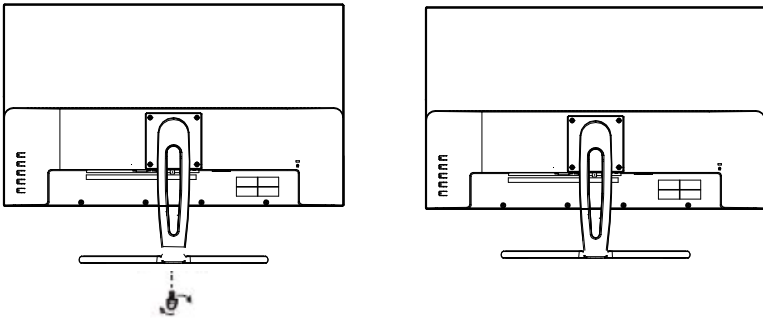

To disassemble the monitor:

1. Put a smooth pad or cloth on a level surface. Place the monitor on it facing downwards.
2. Shrapnel with fingers or similar objects hold the base below, carefully detach the supporting arm from the foot by pressing the groove on the back of the supporting arm. (Note that the fixation point can be broken if too much force is applied). See figures below.

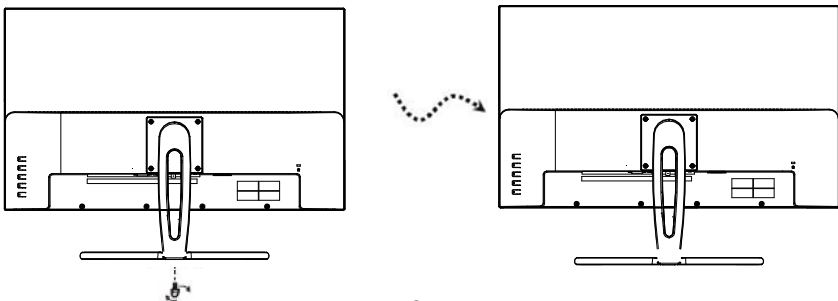

WALL HANGING STANDARD

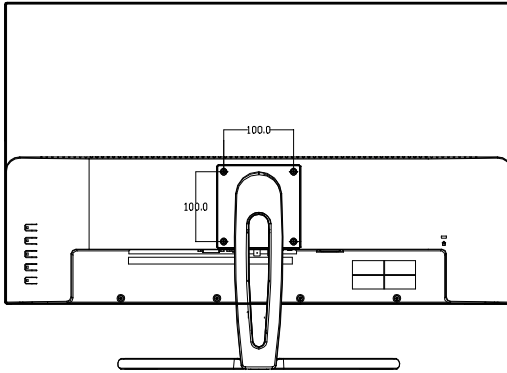

The monitor's installation surface is compatible with other types of VESA standard stands.

Hole spacing: 100 x 100 mm

Screw length: 8 to 12 mm

THE FUNCTION OF THE INTERFACE

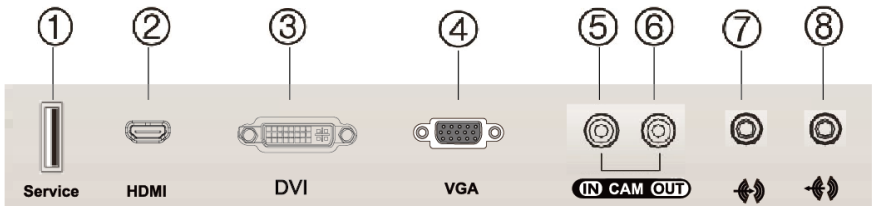

1. Service: USB display and service input.
2. HDMI: HDMI signal input.
3. DVI: DVI signal input.
4. VGA: RGB signal input.
5. CAM IN: VIDEO signal Input .
6. CAM OUT: VIDEO signal output.
7. Stereo Input: AUDIO signal input .
8. Stereo Out : AUDIO signal out.

FRONT PANEL CONTROLS

Control panel

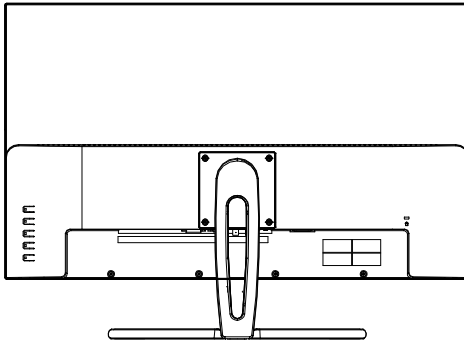

1	MENU
2	▲
3	▼
4	AUTO
5	⏻

1. POWER indicator

Show both normal operation and power management status with powerLED

2. POWER

Switch the monitor on and off.

3. MENU

Turn the OSD window on.

Secondary Function: Turns the OSD window off and moved from sub menu to top menu in the OSD window.

4. ▲ (Up Arrow (*))

Primary Function: Used to select from different input source.

Secondary Function: Moves cursor to the down in the OSD window and decreases the value of any selected menu.

5. ▼ (Down Arrow (*))

Primary Function: Used to adjust the volume.

Secondary Function: Moves cursor to the up in the OSD (On-Screen Display) window and increases the value of any selected menu.

6. AUTO (*)

Primary Function: Automatically adjusts the display to the most optimal setting possible. (VGA mode only)

Secondary Function: Selects sub menu.

FRONT PANEL CONTROLS

Changing a monitor parameter

Press the **MENU** button on the front panel to obtain the OSD menuscreen.

1. Use Up-Down buttons to select the menu.
2. Use AUTO button to select the submenus.
3. Use Up-Down buttons to select a submenu function.
4. Press AUTO button, then using Up-Down buttons you can make adjustments as necessary.
5. To exit, press **MENU**.

Hot keys

▲ Up Arrow	When there is no OSD, to select input signal source. AV-HDMI-DVI-VGA-USB
▼ Down Arrow	When there is no OSD, you can adjust the volume directly.
AUTO	Automatically choose the correct horizontal and vertical position and the size of the screen image (VGAonly).

OSD FUNCTION

Configure the monitor using the on-screen display (OSD) menus and submenus. Changes are immediately saved and implemented.

VGA menu

- Video

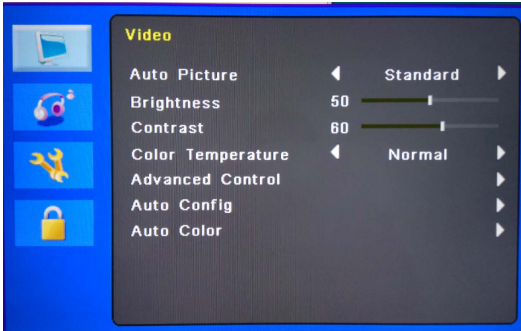

(Advanced Control)

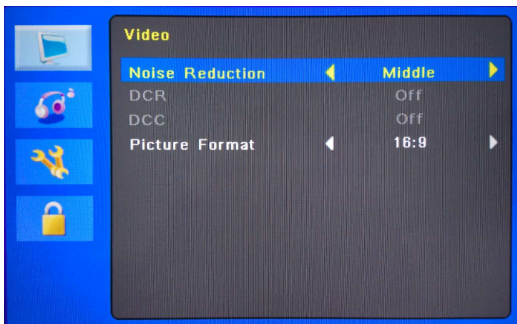

(Auto Config)

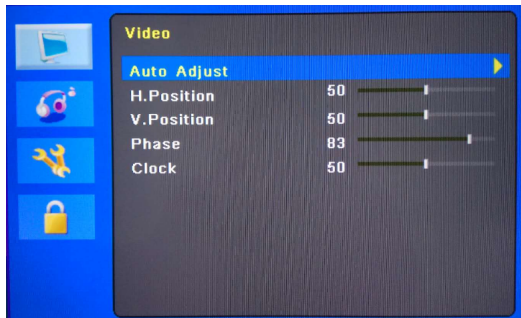

OSD FUNCTION

1. Brightness

Adjust the brightness of the image.

2. Contrast

Adjust the contrast of the image, the difference between light and dark area on the screen.

3. Color Temperature

Choose a different preset color temperature or set your own customized color parameters.(Normal/ Warm/ Cool/User).

4. Advanced Setting

4-1 Noise Reduction

4-2 DCR (not support)

4-3 DCC (not support)

4-4 Picture Format

Select the aspect ratio

5. Auto Config

5-1 Auto adjust

Automatically choose the correct horizontal position and vertical position and size of the screen image.

5-2 H-Position

Adjust the position of the display horizontally (left or right).

5-3 V-Position

Adjust the position of the display vertically (up or down).

5-4 Phase

Remove any horizontal noise and clear or sharpen the image of the characters.

5-5 Clock

Adjust the width (horizontal size) of the screen image.

6. Auto Color

Operate the white balance and automatically adjust the color settings.(Available only during VGA input source signal)

OSD FUNCTION

Cam menu

● Video

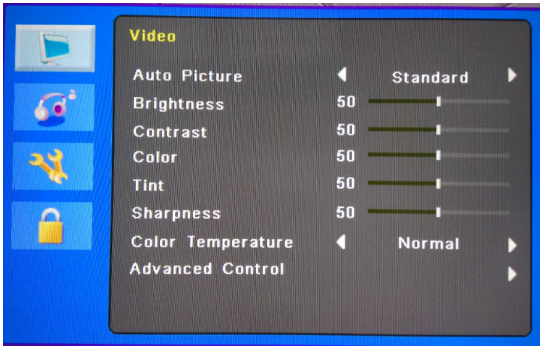

(Advanced Control)

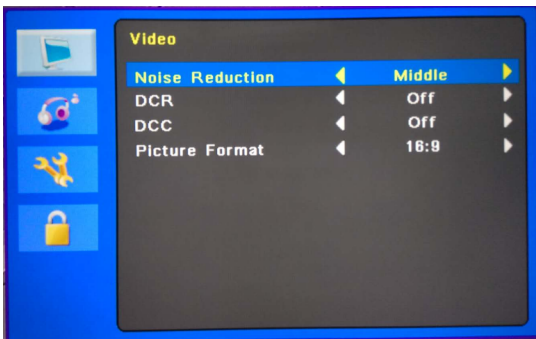

1. Auto Picture

Select the picture mode (Standard/Movie/ECO/Personal/Vivid).

2. Brightness

Adjust the brightness of the image.

3. Contrast

Adjust the contrast of the image, the difference between light and dark areason the screen.

4. Color

Adjust the color of the image.

5. Tint

Adjust tint of the image.
Only for NTSC signal.

OSD FUNCTION

6. Sharpness

Adjust the display image quality (if the screen proceeds to scaling up).

7. Color Temperature

Choose a different preset color temperature or set your own customized color parameters (Normal/ Warm/ Cool/User).

8. Advanced Control

8-1 Noise Reduction

Reduce the noise in the picture due to poor reception or poor picture quality.
(Middle/ High/Off/Low)

8-2 DCR

Turn DCR on or off.

8-3 DCC

Turn DCC on or off.

8-4 Picture Format

Select the aspect ratio

HDMI menu

• Video

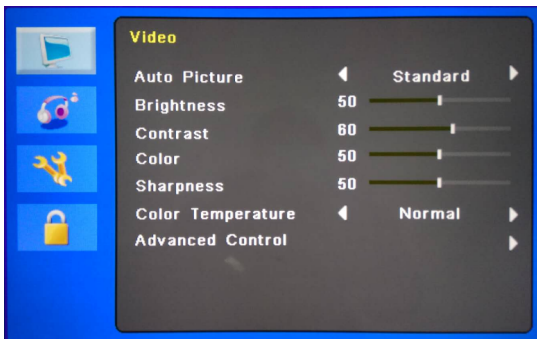

OSD FUNCTION

(Advanced Control)

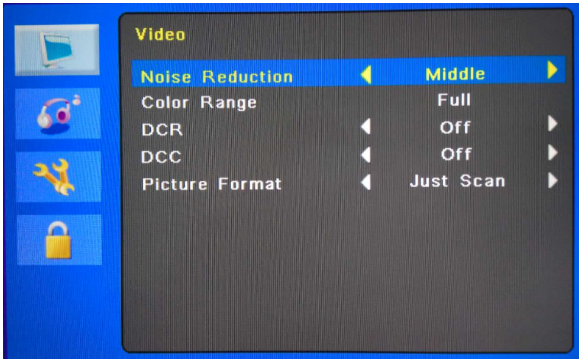

1. Auto Picture

Select the picture mode (Standard/Movie/ECO/Personal/Vivid).

2. Brightness

Adjust the brightness of the image.

3. Contrast

Adjust the contrast of the image, the difference between light and dark areas on the screen.

4. Color

Adjust the color of the image.

5. Sharpness

Adjust the display image quality (if the screen proceeds to scaling up).

6. Color Temperature

Choose a different preset color temperature or set your own customized color parameters (Normal/Warm/Cool/User).

7. Advanced Control

7-1 Noise Reduction

Reduce the noise in the picture due to poor reception or poor picture quality. (Off/Low/Middle/High).

7-2 Color Range

Select the color format (Full/Limit).

OSD FUNCTION

7-3 DCR

Turn DCR on or off.

7-4 DCC

Turn DCC on or off.

7-5 Picture Format

Select the aspect ratio (Just Scan/ OverScan)

DVI menu

• Video

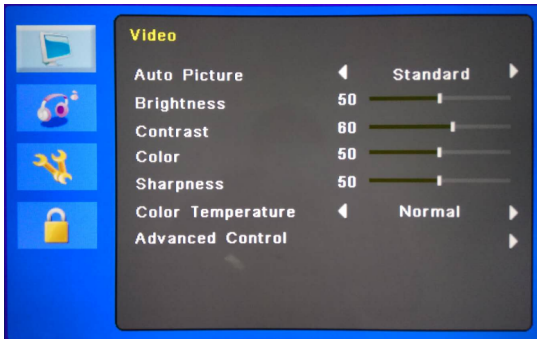

(Advanced Control)

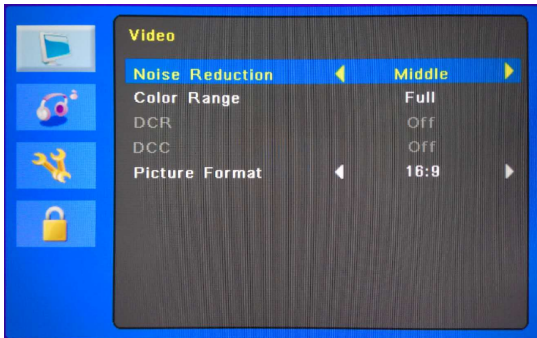

OSD FUNCTION

1. Auto Picture

Select the picture mode (Standard/Movie/ECO/Personal/Vivid).

2. Brightness

Adjust the brightness of the image.

3. Contrast

Adjust the contrast of the image, the difference between light and dark area on the screen.

4. Color

Adjust the color of the image.

5. Sharpness

Adjust the display image quality (if the screen proceeds to scaling up).

6. Color Temperature

Choose a different preset color temperature or set your own customized color parameters (Normal/ Warm/ Cool/User).

7. Advanced Control

7-1 Noise Reduction

Reduce the noise in the picture due to poor reception or poor picture quality. (Off/Low/ Middle/ High).

7-2 Color Range

Select the color format(Full/Limit).

7-3 DCR

Not used..

7-4 DCC

Not used.

7-5 Picture Format

Select the aspect ratio

OSD FUNCTION

● Audio

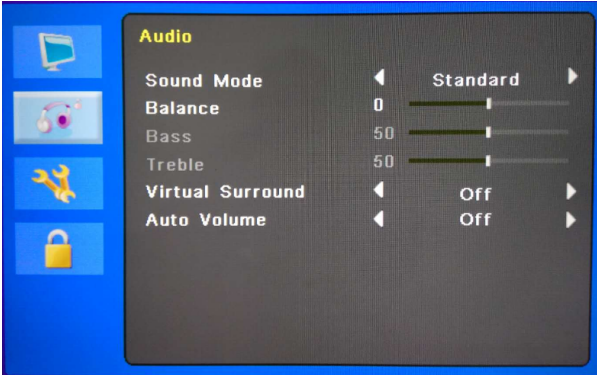

1. Sound Mode

Choose a different preset sound mode or your own customized sound.
(Music/ Speech/ Personal/ Standard)

2. Balance

Adjust the sound balance of the left and right speakers.

3. Bass

When you select Personal mode, adjust the bassound.

4. Treble

When you select the Personal mode, adjust the treble sound.

5. Virtual Surround

Provide an enhanced listeningexperience.

6. Auto Volume

Automatically remains at the same volume level if you change the program.

OSD FUNCTION

● Setting

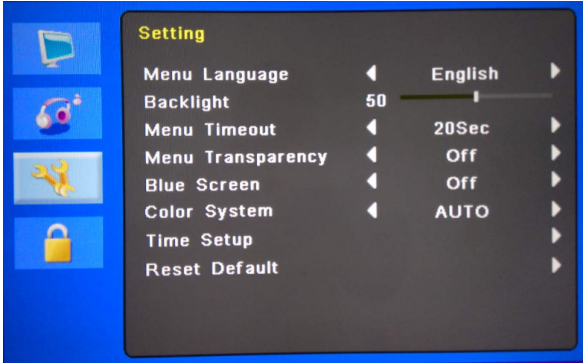

1. Menu Language

Select the OSD language.

2. Backlight

Adjust the brightness of the image.

3. Menu Time Out

Adjust the display time of the OSD menu (10 to 60seconds).

4. Menu Transparency

Adjust the OSD transparency.

5. Blue Screen

When there is no signal input, select the blue background color.

6. Color System

Select the input signal system Auto or PAL, PAL-60, NTSC, NTSN_44, SECAM.
(AV mode optional)

7. Time Setup

7-1 Time

Not used.

7-2 Sleep Timer

Set the sleep ON/OFF(VGA/HDMI/DVI mode).

7-3 Anti-Burn-In

Screen Burn Protection (optional) .

8. Reset Default

Reset the screen to the factory preset display settings.

OSD FUNCTION

● Child Lock



1. Keypad Lock

Turn the keypad lock on or off.

Keyboard lock unlock method: Long press "MENU" key for about 8 seconds, can be unlocked.

SELF-DIAGNOSIS

If there is no image, the Self-Diagnosis screen will be displayed. The self-diagnosis function checks if the status of the monitor screen is No Signal, Out of Range or None Supported.

A black rectangular box with the text "No Signal" in white, centered.

No Signal

The **No Signal screen** is displayed when the D-Sub signal connector is connected but the status of the monitor is on DPMS mode.

A black rectangular box with the text "Out of Range" in white, centered.

Out of Range

The **Out of Range** screen is displayed when the applied frequency is under or over normal range.

Normal range (Non-interlaced mode only):

H: 30 to 80 kHz

V: 50 to 76 Hz

Remote Control FUNCTION (optional)

- R1 POWER
Turns the monitor on from stand-by or off to stand-by mode.
- R2 TV/AV (input source)
Selects the signal source from multiple input sources.
- R3 MUTE
Turns the sound on and off.
- R4 NUMBER Buttons
- R5 LAST CH
Not used.
- R6 INFO
Information display.
- R7 PICT MODE
Selects preferred picture settings.
- R8 SLEEP
Set the sleep timer.
- R9 MENU
Display a main menu.
- R10 EXIT
Turns the OSD window off and moves from submenu to top menu in the OSD window.

Press UP/DOWN buttons to enter the Function menu.

R12 / R14 LEFT/RIGHT ◀/▶ Buttons

- R13 OK
Selects menu items.
- R15 VOL +/-
Adjust the sound level.
- R16 CH +/-
Not used.
- R18 ADD/ERASE
Not used.

R11/R17 UP/DOWN Buttons

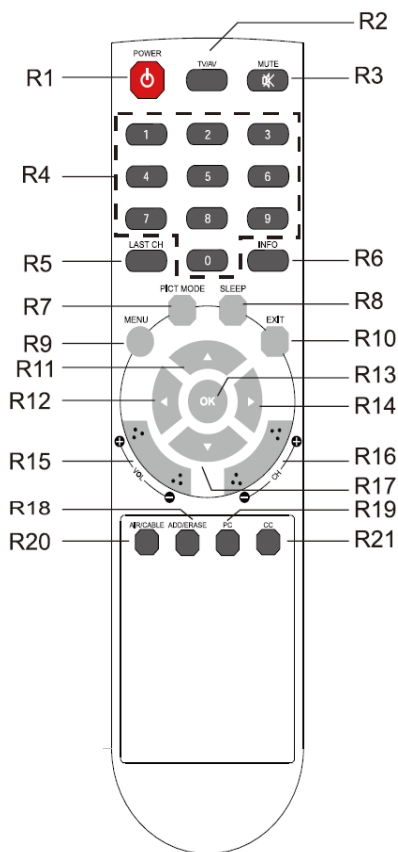

- R19 PC
Directly selects VGA mode. Selects PC mode. (VGA mode only)
- R20 AIR/CABLE
Not used.
- R21 CC
Not used.

TROUBLESHOOTING

Symptom	Check
Picture is jittery	Adjust Clock to set the screen position and adjust the Clock value carefully until there is no noise displayed.
No picture	Check if the power switch and computer power switch are in the On position. Check if the signal cable is correctly connected to the video card. Check if the pins of D-sub connector are not bent. Check if the computer is in the power- saving mode.
POWER LED is not lit	Check if the power switch is in the On position. Check if the power cord is correctly connected.
Image is unstable	Check if the signal cable is suitable to the video card.
Picture bounces or a wave pattern is present in the picture	Keep the devices that may cause electrical interference away from the monitor. See the FCC information at the front cover of the manual.
Picture is blurred	Adjust Contrast and Brightness.
No sound	Check the audio cables are correctly connected to the computer. Adjust the volume after checking the sound is muted. Check the audio system in the computer.
Low sound	Adjust the volume on the OSD menu. Adjust the volume of the sound card in the computer.
VIDEO screen cannot be seen	Check if PICTURE mode has been set. Check if the video terminal is properly connected.
No video	Check if the video cable is correctly connected to the computer and set to Functions on the OSD picture menu.
Poor color in the video	Adjust the Color or Tint values on the OSD Picture menu.
Grainy picture in the video	Adjust the Sharpness on the OSD Picture menu.

SPECIFICATIONS

Items		DS-D5032 Serial
Panel	Screen size	32" (80.1 cm)
	Max. Resolution	1920 x 1080
Frequency (H/V)		H: 30 kHz –80 kHz V: 50 Hz –76 Hz
Interface	VGA in (15 Pin D-Sub)	1
	HDMI in	1
	DVI in	1
	BNC (in/out)	1/1
	PC Audio in	Yes
	Head phone out	Yes
	USB	Yes
Audio	Speaker power	2 W x 2
	Speakers	Built-in
	Sound features	Stereo R/L
Power	Consumption	≤55 W
	Source	100-240V 50/60HZ
Operation Conditions	Temperature	5°C ~ 35°C
	Humidity	20%~85%
Storage Conditions	Temperature	-20°C ~ 55°C
	Humidity	5%~85%
Weight	Product weight (with base)	6.57 kg (14.48 lb.)
	Packaging weight	9.25 kg (20.39 lb.)

Note: All specifications are subject to change without prior notice.

SPECIFICATIONS

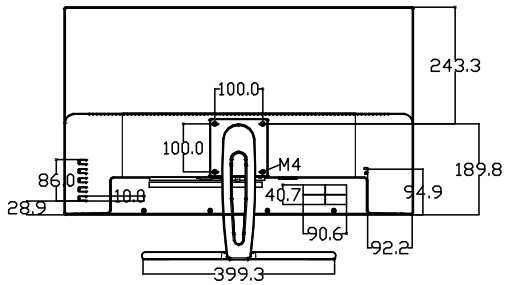
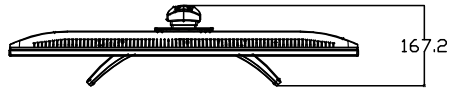
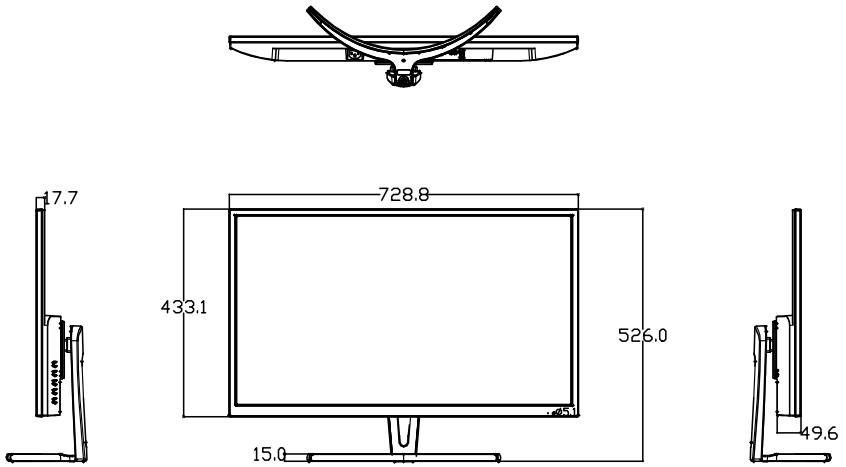

SPECIFICATIONS

Items		DS-D5040 Serial
Panel	Screen size	40" (100.3cm)
	Max. Resolution	1920 x 1080
Frequency (H/V)		H: 30 kHz –80 kHz V: 50 Hz –76 Hz
Interface	VGA in (15 Pin D-Sub)	1
	HDMI in	1
	DVI in	1
	BNC (in/out)	1/1
	PC Audio in	Yes
	Head phone out	Yes
	USB	Yes
Audio	Speaker power	2 W x 2
	Speakers	Built-in
	Sound features	Stereo R/L
Power	Consumption	≤60 W
	Source	100-240V 50/60HZ
Operation Conditions	Temperature	5°C ~ 35°C
	Humidity	20%~85%
Storage Conditions	Temperature	-20°C ~ 55°C
	Humidity	5%~85%
Weight	Product weight (with base)	8.5 kg (18.7 lb.)
	Packaging weight	11.7 kg (25.8 lb.)

Note: All specifications are subject to change without prior notice.

SPECIFICATIONS

