



LCD Monitor

User Manual

User Manual

COPYRIGHT ©2018 Hangzhou Hikvision Digital Technology Co., Ltd.

ALL RIGHTS RESERVED.

Any and all information, including, among others, wordings, pictures, graphs are the properties of Hangzhou Hikvision Digital Technology Co., Ltd. or its subsidiaries (hereinafter referred to be “Hikvision”). This user manual (hereinafter referred to be “the Manual”) cannot be reproduced, changed, translated, or distributed, partially or wholly, by any means, without the prior written permission of Hikvision. Unless otherwise stipulated, Hikvision does not make any warranties, guarantees or representations, express or implied, regarding to the Manual.

About this Manual

This Manual is applicable to the Monitor.

The Manual includes instructions for using and managing the product. Pictures, charts, images and all other information hereinafter are for description and explanation only. The information contained in the Manual is subject to change, without notice, due to firmware updates or other reasons. Please find the latest version in the company website (<http://overseas.hikvision.com/en/>).

Please use this user manual under the guidance of professionals.

Trademarks Acknowledgement

HIKVISION and other Hikvision’s trademarks and logos are the properties of Hikvision in various jurisdictions. Other trademarks and logos mentioned below are the properties of their respective owners.

Legal Disclaimer

TO THE MAXIMUM EXTENT PERMITTED BY APPLICABLE LAW, THE PRODUCT DESCRIBED, WITH ITS HARDWARE, SOFTWARE AND FIRMWARE, IS PROVIDED “AS IS”, WITH ALL FAULTS AND ERRORS, AND HIKVISION MAKES NO WARRANTIES, EXPRESS OR IMPLIED, INCLUDING WITHOUT LIMITATION, MERCHANTABILITY, SATISFACTORY QUALITY, FITNESS FOR A PARTICULAR PURPOSE, AND NON-INFRINGEMENT OF THIRD PARTY. IN NO EVENT WILL HIKVISION, ITS DIRECTORS, OFFICERS, EMPLOYEES, OR AGENTS BE LIABLE TO YOU FOR ANY SPECIAL, CONSEQUENTIAL, INCIDENTAL, OR INDIRECT DAMAGES, INCLUDING, AMONG OTHERS, DAMAGES FOR LOSS OF BUSINESS PROFITS, BUSINESS INTERRUPTION, OR LOSS OF DATA OR DOCUMENTATION, IN CONNECTION WITH THE USE OF THIS PRODUCT, EVEN IF HIKVISION HAS BEEN ADVISED OF THE POSSIBILITY OF SUCH DAMAGES.

REGARDING TO THE PRODUCT WITH INTERNET ACCESS, THE USE OF PRODUCT SHALL BE WHOLLY AT YOUR OWN RISKS. HIKVISION SHALL NOT TAKE ANY RESPONSIBILITIES FOR ABNORMAL OPERATION, PRIVACY LEAKAGE OR OTHER DAMAGES RESULTING FROM CYBER ATTACK, HACKER ATTACK, VIRUS INFESTATION, OR OTHER INTERNET SECURITY RISKS; HOWEVER, HIKVISION WILL PROVIDE TIMELY TECHNICAL SUPPORT IF REQUIRED.

SURVEILLANCE LAWS VARY BY JURISDICTION. PLEASE CHECK ALL RELEVANT LAWS IN YOUR JURISDICTION BEFORE USING THIS PRODUCT IN ORDER TO ENSURE THAT YOUR USE CONFORMS THE APPLICABLE LAW. HIKVISION SHALL NOT BE LIABLE IN THE EVENT THAT THIS PRODUCT IS USED WITH ILLEGITIMATE PURPOSES.

IN THE EVENT OF ANY CONFLICTS BETWEEN THIS MANUAL AND THE APPLICABLE LAW, THE LATER PREVAILS.

Regulatory Information

FCC Information

Please take attention that changes or modification not expressly approved by the party responsible for compliance could void the user's authority to operate the equipment.

FCC compliance: This equipment has been tested and found to comply with the limits for a Class A digital device, pursuant to part 15 of the FCC Rules. These limits are designed to provide reasonable protection against harmful interference when the equipment is operated in a commercial environment. This equipment generates, uses, and can radiate radio frequency energy and, if not installed and used in accordance with the instruction manual, may cause harmful interference to radio communications. Operation of this equipment in a residential area is likely to cause harmful interference in which case the user will be required to correct the interference at his own expense

FCC Conditions

This device complies with part 15 of the FCC Rules. Operation is subject to the following two conditions:

1. This device may not cause harmful interference.
2. This device must accept any interference received, including interference that may cause undesired operation.

EU Conformity Statement



This product and - if applicable - the supplied accessories too are marked with "CE" and comply therefore with the applicable harmonized European standards listed under the EMC Directive 2014/30/EU, the LVD Directive 2014/35/EU, the ROHS Directive 2011/65/EU.



2012/19/EU (WEEE directive): Products marked with this symbol cannot be disposed of as unsorted municipal waste in the European Union. For proper recycling, return this product to your local supplier upon the purchase of equivalent new equipment, or dispose of it at designated collection points. For more information see: www.recyclethis.info



2006/66/EC (battery directive): This product contains a battery that cannot be disposed of as unsorted municipal waste in the European Union. See the product documentation for specific battery information. The battery is

marked with this symbol, which may include lettering to indicate cadmium (Cd), lead (Pb), or mercury (Hg). For proper recycling, return the battery to your supplier or to a designated collection point. For more information see: www.recyclethis.info

Industry Canada ICES-003 Compliance

This device meets the CAN ICES-3 (A)/NMB-3(A) standards requirements.

Applicable Models

This manual is applicable to the model: LCD Monitor.

Symbol Conventions

The symbols that may be found in this document are defined as follows.



Symbol	Description
 NOTE	Provides additional information to emphasize or supplement important points of the main text.
 WARNING	Indicates a potentially hazardous situation, which if not avoided, could result in equipment damage, data loss, performance degradation, or unexpected results.
 DANGER	Indicates a hazard with a high level of risk, which if not avoided, will result in death or serious injury.

TABLE OF CONTENTS

1.Introduction	1
1.1 Key Features.....	1
1.2 Power Supply Connection.....	1
2.Device Interfaces	2
3.Panel keys	2
4.Basic Operation	3
Specifications	9
Structure Figure	10

Chapter 1. Introduction

1.1 Key Features

- DS-D5019 Series:Support 1366×768 HD display;
- DS-D5022/5024/5027 Series:Supports 1920×1080 FHD display;
- User-friendly operation menu;
- Three image modes to adapt different environment;
- 1 channel HDMI 1.3 input interface;
- Support software spread-spectrum technology to reduce EMI radiation; Standby Power Consumption is lower than 0.5W;
- DS-D5019 Series:Viewing Angle:Horizontal 90°, Vertical 65° ;
- DS-D5022QE-B:Viewing Angle:Horizontal 170°, Vertical 160° ;
- DS-D5022QE-E:Viewing Angle:Horizontal 90°, Vertical 65° ;
- DS-D5024QE:Viewing Angle:Horizontal 178°, Vertical 178° ;
- DS-D5027QE:Viewing Angle:Horizontal 170°, Vertical 170° ;
- 2Wx2 Speakers efficient output(optional);

1.2 Power Supply Connection

Insert the 3-pin power device into well-grounded socket and turn the rocker switch on.

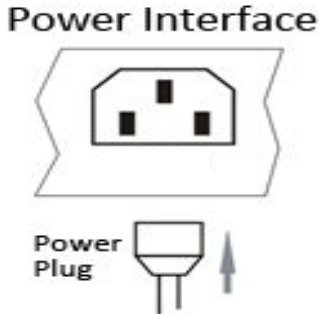

Figure 1.1 Power Input

- Power input specification from 100VAC to 240VAC or provide automatic switching between high line and low line input ranges.
- Turn off the main power switch of the display unit, and pull the plug from the power outlet if the display unit will not be used for a long time.
- Never connect the device to a DC power.

Chapter2. Device Interfaces

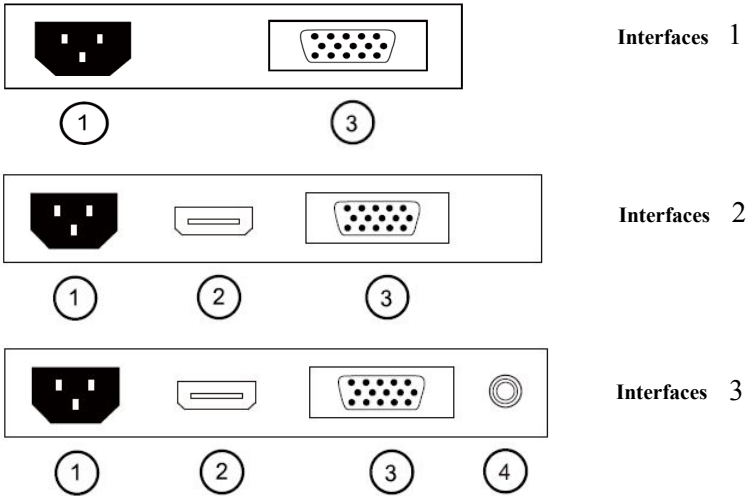

Figure 2.1 Rear Panel of Device

Interfaces	Interfaces 1	Interfaces 2	Interfaces 3
POWER IN (1)	Power Input	Power Input	Power Input
VGA IN (3)	VGA Analog Signal Input	VGA Analog Signal Input	VGA Analog Signal Input
HDMI IN (2)		HDMI Digital Signal Input	HDMI Digital Signal Input
AUDIO IN (4)			Audio Input

Chapter3. Panel Keys

Keys on lower right corner of the display unit panel are shown in the Figure 3.1 Keys on the Display Unit.



Figure 3.1 Keys on the Display Unit

The functions of the keys on lower right corner of the display unit vary according to different situations.

Chapter4. Basic Operation

4.1 Input Source Selection(optional)

Turn on the display unit when the power supply is on and input source is confirmed.

Press ◀ key of the remote controller to enter the menu as shown on the right. DS-D5019/22 /24/27inch LCD display unit includes 2 input sources as HDMI and VGA signal. Press direction keys to select the input source and press MENU to accomplish the input source selection.



Figure 4.1 Input Source

4.1 Contrast

Press ◀ key of the remote controller to enter the menu as shown on the right. press ◀ or ▶ to adjust the value of contrast. Press MENU to accomplish the contrast adjustment.



Figure 4.1 Input Source

4.2 Input Audio Volume Adjustment(optional)

Turn on the display unit when the power supply is on and input source is confirmed.

Press ▶ key of the remote controller to enter the menu as shown on the right. press ◀ or ▶ to adjust the value of volume. press MENU to accomplish the volume adjustment.



Figure 4.2 Audio Volume

4.2 Brightness

Press ▶ key of the remote controller to enter the menu as shown on the right. press ◀ or ▶ to adjust the value of Brightness. press MENU to accomplish the Brightness adjustment.



Figure 4.2 Brightness

4.3 Auto Adjust

Turn on the display unit when the power supply is on and input source is confirmed.

Press AUTO key of the remote controller to enter the menu as shown on the right(In VGA Signal).

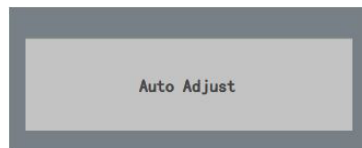

Figure 4.3 Input Source

4.4 Main Menu

4.4.1 Image Settings

Purpose:

You can adjust the picture parameters by switching image modes and adjust the values of contrast, brightness, color temperature, auto adjust, color adjust.

Steps:

1. Press **MENU** key to enter the main menu interface as shown below.
2. Press **MENU** key to enter the setting you want.
3. Press **◀** or **▶** to adjust the value. It applies for adjusting contrast, brightness, color temp and other parameters.



- Contrast, Brightness: Press **◀** or **▶** to set the contrast, the range varies from 0-100.
- Color temperature :Press **◀** or **▶** to set the color temperature you need.
- Gray indicates that under current mode or current input source condition it is not adjustable; Yellow indicates that it is adjustable.

4. Press **AUTO** key to return to the main menu after accomplishing the adjustment.

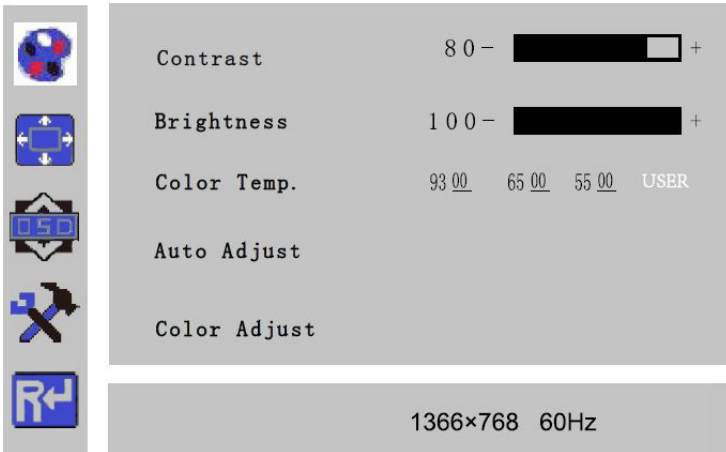

Figure 4.4.1 Image Settings

4.4.2 Image Adjustment

Purpose:

When the input source is selected VGA, you can adjust the VGA parameters. It is for adjusting VGA H position, V Position, clock and phase.

Steps:

1. Press **Menu** key to enter the main menu interface.
2. Press **◀** key to enter the VGA parameter setting interface. (You can select **Auto Adjust** and press **◀** or **▶** to adjust the VGA parameters automatically or adjust it manually)
3. Select **H Position** and press **◀** or **▶** to adjust the **H Position**
4. Select **V Position** and press **◀** or **▶** to adjust the **V position**.
5. Select **Clock** and press **◀** or **▶** to adjust the **clock**.
6. Select **Phase** and press **◀** or **▶** to adjust the **phase**.



The range of the adjustment varies between 0-100.

7. Press **MENU** key to return to the main menu after accomplishing the adjustment.

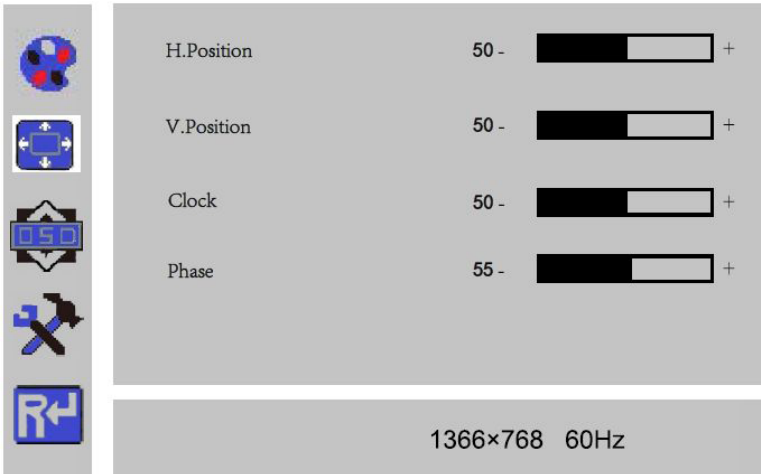

Figure 4.4.2 Image Adjustment

4.4.3 OSD Setting

Purpose:

You can set the language, blending and OSD duration of the menu.

Steps:

1. Press **MENU** key to enter the main menu interface.
2. Press **◀** key twice and press **MENU** key to enter the **【Language】** interface, press **◀** or **▶** to switch the language you want.
3. Select **OSD H.Pos/OSD V.Pos** to adjust the position of OSD with **◀** or **▶**.
4. Select **OSD Timer** to adjust the OSD duration with **◀** or **▶**: **5Sec~60Sec**.
5. Select **Transparency** to adjust the OSD transparency value with **◀** or **▶**.
6. Press **AUTO** key to return to the main menu after accomplishing the adjustment.

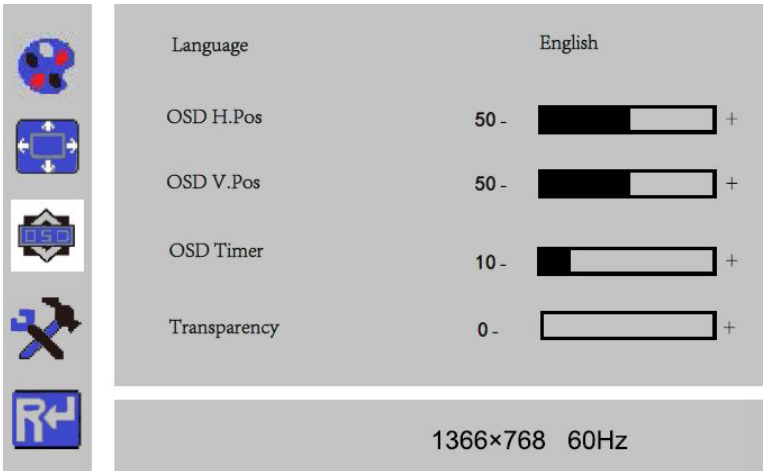

Figure 4.4.3 OSD Setting

4.4.4 Other Settings

Purpose:

You can set Mode, Audio Volume, Signal Source, Aspect Ratio, DCR.

Steps:

1. Press **MENU** key to enter the main menu interface.
2. Press triple ◀ key and press MENU key to enter the **Mode** interface, press ◀ or ▶ to switch the mode between **PC/GAME/MOVIE**.
3. Press ◀ or ▶ to adjust the **Audio Volume** from 0~100(optional).
4. Press ◀ or ▶ to change the **Signal Source** between **VGA** and **HDMI**(optional).
5. Press ◀ or ▶ to switch the **Aspect Ratio** between **16:9/AUTO/4:3**.
6. Press ◀ or ▶ to switch the **DCR On/Off**.
7. Press **MENU** key to return to the main menu after accomplishing the adjustment.

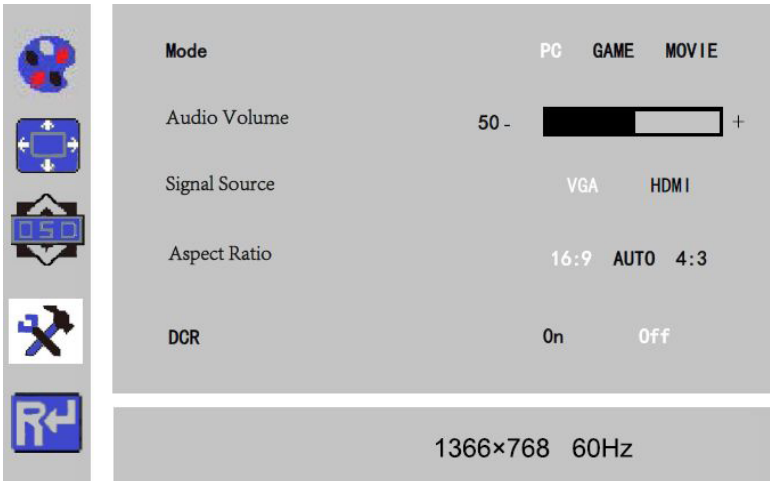

Figure4.4.4 Other Settings

4.4.5 Reset Setting

Purpose:

You can reset settings to the factory defaults.

Steps:

1. Press **MENU** key to enter the main menu interface.
2. Press **◀** key 4 times and press **MENU** key to reset settings to the factory defaults.

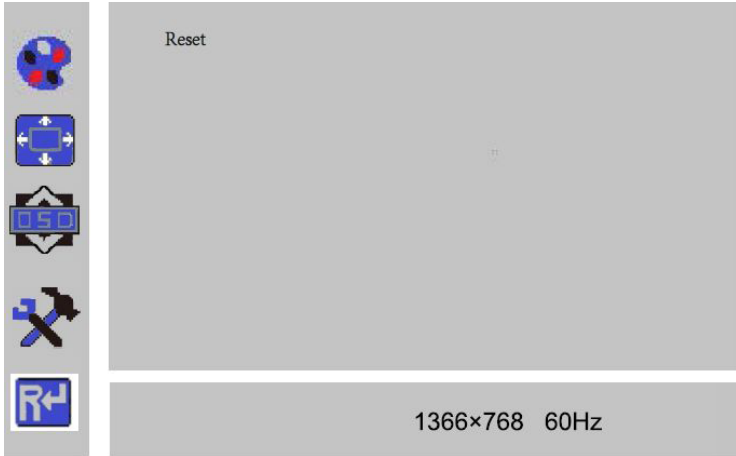
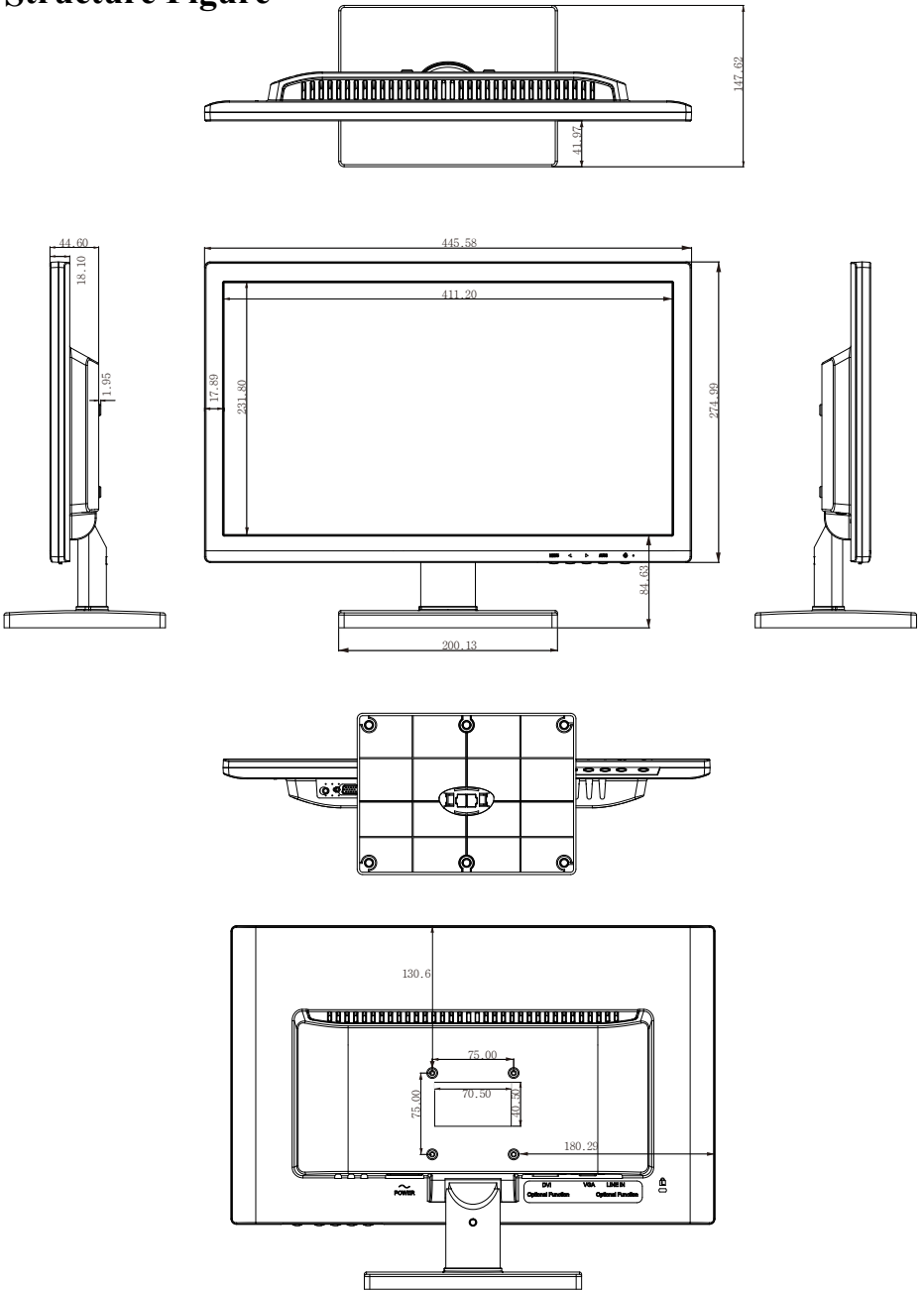

Figure 4.4.5 Reset Setting

Appendix: Specifications

Device Model	DS-D5019 Series			
Display Type	TFT-LED Backlight			
Screen Size	18.5"			
Color	16.7M			
Dot Pitch	0.300×0.300 mm			
Max Resolution	1366×768			
Best Operation Resolution	1366×768@60Hz			
Brightness	200cd/m ²			
Contrast	600:1			
Viewing Angle	Horizontal 90°, Vertical 65°			
Viewable Area	409.8×230.4mm			
		Interfaces 1	Interfaces 2	Interfaces 3
Interfaces	VGA Input Port	1	1	1
	AC Input Port	1	1	1
	HDMI Input Port	NA	1	1
	AUDIO Input Port	NA	NA	1
Power Supply	AC 100-240V; 50/60Hz			
Consumption	≤25W			
Standby Power Consumption	≤0.5W			
Operation Temperature	0°C~40°C (32°F~104°F)			
Operation Humidity	10%~85%			
Storage Temperature:	-20°C~60°C (-4°F~140°F)			
Storage Humidity:	5%~95%			
Bezel Material	Plastic			
Bezel Color	Black			
Wall-mounting Dot Site	75×75mm			
Wall-mounting Thread	M4			
Device Dimensions	446×335×148mm			
Package Dimensions	490×345×101mm			
G.W.	3.1Kg			
N.W.	2.4Kg			
Standard Package	Display Unit	1		
	VGA Cord	1		
	User Manual	1		
	Power Cord	1		
	HDMI Cord(optional)	1		

Structure Figure



Appendix: Specifications

Device Model	DS-D5022QE-B		
Display Type	TFT-LED Backlight		
Screen Size	21.5"		
Dot Pitch	0.248×0.248 mm		
Max Resolution	1920×1080		
Best Operation Resolution	1920×1080@60Hz		
Brightness	250cd/m ²		
Contrast	1000:1		
Color	16.7M		
Viewable Area	477×268mm		
Viewing Angle	Horizontal 170°, Vertical 160°		
		Interfaces 2	Interfaces 3 (optional)
Interfaces2	VGA Input Port	1	1
	HDMI Input Port	1	1
	AC Input Port	1	1
	AUDIO Input Port	NA	1
Power Supply	AC 100-240V; 50/60Hz		
Consumption	≤30W		
Standby Power Consumption	≤0.5W		
Operation Temperature	0°C~40°C (32°F~104°F)		
Operation Humidity	10%~85%		
Storage Temperature:	-20°C~60°C (-4°F~140°F)		
Storage Humidity:	5%~95%		
Bezel Material	Plastic		
Bezel Color	Black		
Wall-mounting Dot Site	100×100mm		
Wall-mounting Thread	M4		
Device Dimensions	511×377×170mm		
Package Dimensions	565×435×105mm		
G.W.	4.0Kg		
N.W.	3.2Kg		
Standard Package	Display Unit	1	
	VGA Cord	1	
	User Manual	1	
	Power Cord	1	
	HDMI Cord(optional)	1	

Appendix: Specifications

Device Model	DS-D5022QE-E		
Display Type	TFT-LED Backlight		
Screen Size	21.5"		
Dot Pitch	0.248×0.248 mm		
Max Resolution	1920×1080		
Best Operation Resolution	1920×1080@60Hz		
Brightness	200cd/m ²		
Contrast	600:1		
Color	16.7M		
Viewable Area	477×268mm		
Viewing Angle	Horizontal 90°, Vertical 65°		
		Interfaces 2	Interfaces 3 (optional)
Interfaces2	VGA Input Port	1	1
	HDMI Input Port	1	1
	AC Input Port	1	1
	AUDIO Input Port	NA	1
Power Supply	AC 100-240V; 50/60Hz		
Consumption	≤30W		
Standby Power Consumption	≤0.5W		
Operation Temperature	0°C~40°C (32°F~104°F)		
Operation Humidity	10%~85%		
Storage Temperature:	-20°C~60°C (-4°F~140°F)		
Storage Humidity:	5%~95%		
Bezel Material	Plastic		
Bezel Color	Black		
Wall-mounting Dot Site	100×100mm		
Wall-mounting Thread	M4		
Device Dimensions	511×377×170mm		
Package Dimensions	565×435×105mm		
G.W.	4.0Kg		
N.W.	3.2Kg		
Standard Package	Display Unit	1	
	VGA Cord	1	
	User Manual	1	
	Power Cord	1	
	HDMI Cord(optional)	1	

Structure Figure

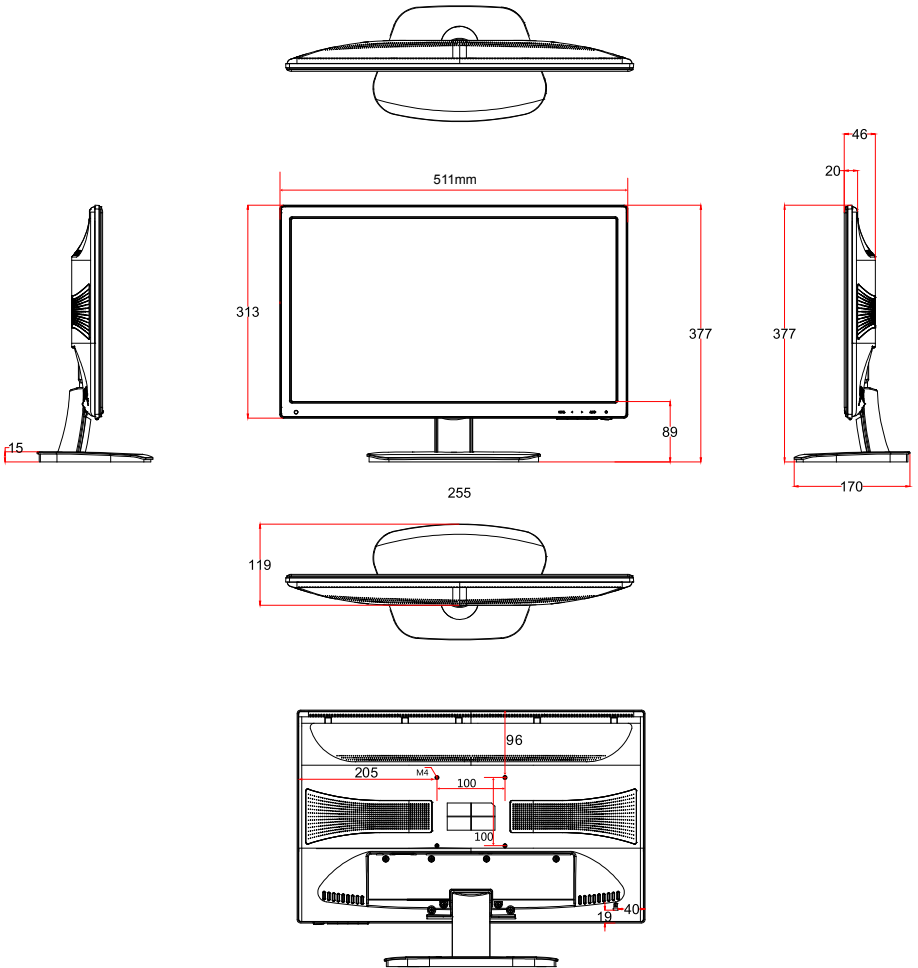

Appendix: Specifications

Device Model	DS-D5024 Series		
Display Type	TFT-LED Backlight		
Screen Size	23.8"		
Color	16.7M		
Dot Pitch	0.2745×0.2745mm		
Max Resolution	1920×1080		
Best Operation Resolution	1920×1080@60Hz		
Brightness	250cd/m ²		
Contrast	1000:1		
Viewing Angle	Horizontal 178°, Vertical 178°		
Viewable Area	527×296mm		
		Interfaces 2	Interfaces 3 (optional)
Interfaces	VGA Input Port	1	1
	AC Input Port	1	1
	HDMI Input Port	1	1
	AUDIO Input Port	NA	1
Power Supply	AC 100-240V; 50/60Hz		
Consumption	≤30W		
Standby Power Consumption	≤0.5W		
Operation Temperature	0°C~40°C (32°F~104°F)		
Operation Humidity	10%~85%		
Storage Temperature:	-20°C~60°C (-4°F~140°F)		
Storage Humidity:	5%~95%		
Bezel Material	Plastic		
Bezel Color	Black		
Wall-mounting Dot Site	100×100mm		
Wall-mounting Thread	M4		
Device Dimensions	555×433×226mm		
Package Dimensions	619×409×155mm		
G.W.	5.1Kg		
N.W.	3.7Kg		
Standard Package	Display Unit	1	
	VGA Cord	1	
	User Manual	1	
	Power Cord	1	
	HDMI Cord(optional)	1	

Structure Figure

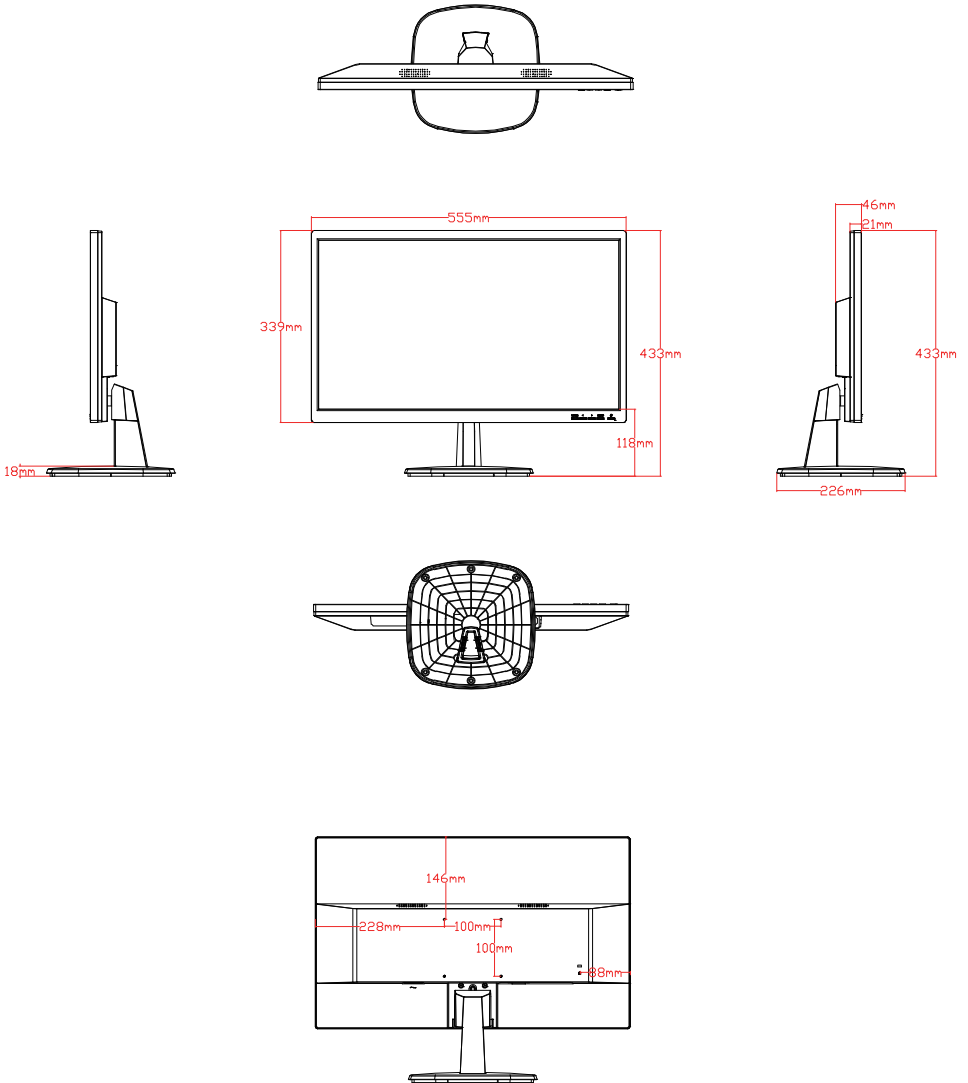

Appendix: Specifications

Device Model	DS-D5027 Series		
Display Type	TFT-LED Backlight		
Screen Size	27"		
Color	16.7M		
Dot Pitch	0.311×0.311mm		
Max Resolution	1920×1080		
Best Operation Resolution	1920×1080@60Hz		
Brightness	250cd/m ²		
Contrast	1000:1		
Viewing Angle	Horizontal 170°, Vertical 170°		
Viewable Area	598×336mm		
		Interfaces 2	Interfaces 3 (optional)
Interfaces	VGA Input Port	1	1
	AC Input Port	1	1
	HDMI Input Port	1	1
	AUDIO Input Port	NA	1
Power Supply	AC 100-240V; 50/60Hz		
Consumption	≤35W		
Standby Power Consumption	≤0.5W		
Operation Temperature	0°C~40°C (32°F~104°F)		
Operation Humidity	10%~85%		
Storage Temperature:	-20°C~60°C (-4°F~140°F)		
Storage Humidity:	5%~95%		
Bezel Material	Plastic		
Bezel Color	Black		
Wall-mounting Dot Site	100×100mm		
Wall-mounting Thread	M4		
Device Dimensions	646×447×220mm		
Package Dimensions	710×520×117mm		
G.W.	6.7Kg		
N.W.	5.34Kg		
Standard Package	Display Unit	1	
	VGA Cord	1	
	User Manual	1	
	Power Cord	1	
	HDMI Cord(optional)	1	

Structure Figure

